

Research & Development - RF & Microwave Logarithmic Amplifiers (DLVA, ERDLVA, SDLVA)

January 5th, 2024

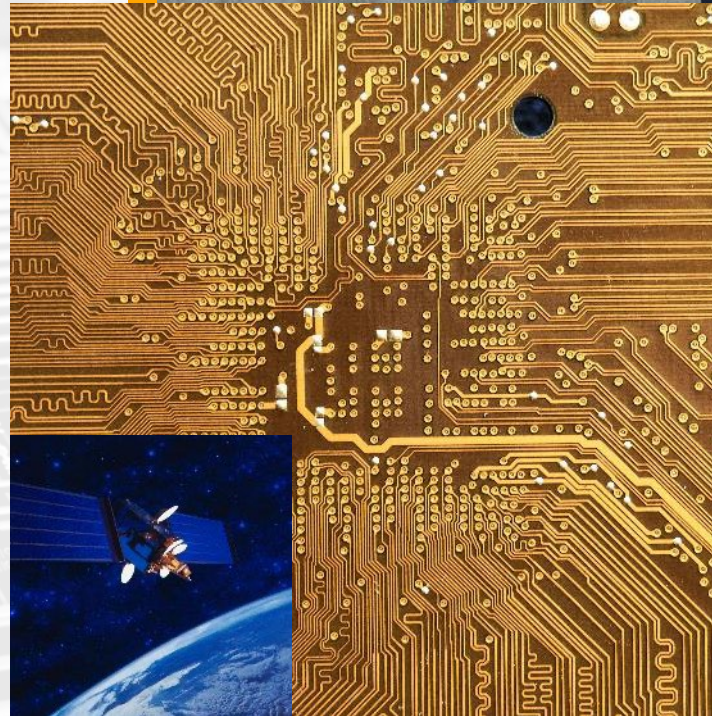

Quantic PMI Overview

Global leader within military, space and commercial markets

- > Design & manufacture of Quality RF & Microwave Components & Integrated Module Assemblies
- > Offers more than 4000 commercial off-the-shelf models with test results, S-parameters, 3D models and detailed specs available.
- > Every product is built to rigorous MIL-STD specs
- > ITAR & ISO-9001 Certifications
- > Industry-leading sales and applications support, leading to lower costs and faster lead times than competitive options.

Design and Manufacturing Locations

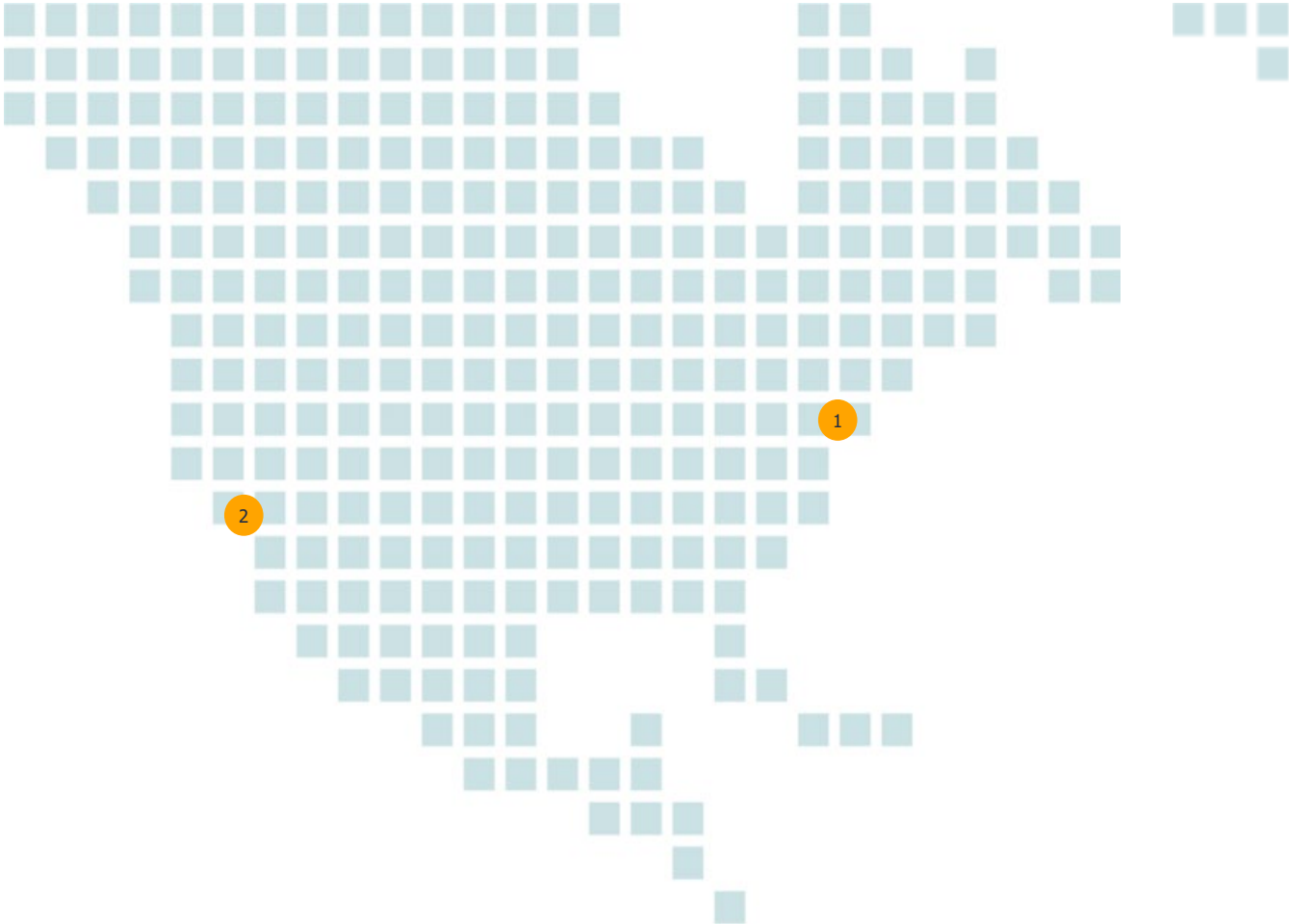

RF & Microwave

- 1 Quantic PMI – Frederick, Maryland
East Coast Operation
7309-A Grove Road
Frederick, MD 21704 USA

- 2 Quantic PMI – EL Dorado Hills, California
West Coast Operation
4921 Robert Mathews PKWY, Suite 1
EL Dorado Hills, CA 95762 USA

Tel: 301.662.5019
Fax: 301.662.1731

TEL: 916.542.1401
FAX: 916.265.2597

sales@quanticpmi.com

www.quanticpmi.com

Research & Development

RF & Microwave Logarithmic Amplifiers
(DLVA, ERDLVA, SDLVA)

- > [Detector Logarithmic Video Amplifiers Overview](#)

- > [Detector Logarithmic Video Amplifiers \(DLVAs\)](#)

- > [Extended Range Detector Logarithmic Video Amplifiers \(ERDLVAs\)](#)

- > [Successive Detection Log Video Amplifiers \(SDLVAs\)](#)

- > [Surface Mount Designs](#)

- > [Form, Fit, Function Products & Services](#)

Detector Logarithmic Video Amplifiers Overview

DC to 40 GHz w/ EXTENDED RANGE MODELS OFFERING DYNAMIC RANGES OVER 70 dB

Standard or Custom Designed Models

> Features

- Broadband Frequency Response
- Excellent Log Linearity
- Exceptional Temperature Stability
- Limited IF Output Provided
- TSS > -70 dBm
- Fast Log Video Response Time
- Low Power Consumption

> Options

- Hermetic Sealing
- Custom Packages
- Surface Mount or Connectorized
- Temperature Compensation
- CW Immunity
- Matched Sets
- Military or Space Screening

> Form, Fit & Function Products & Services



Detector Logarithmic Video Amplifiers (DLVAs)

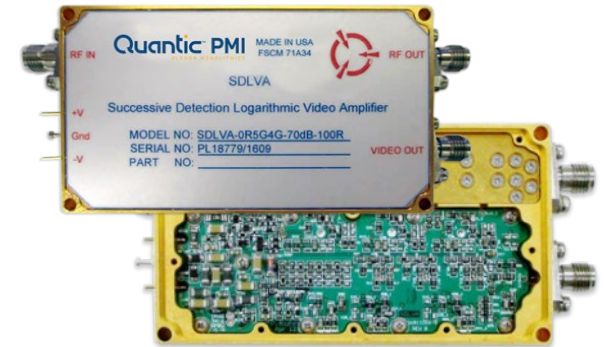

Successive Detection Log Video Amplifiers (SDLVAs)



Extended Range Detector Logarithmic Video Amplifiers (ERDLVAs)

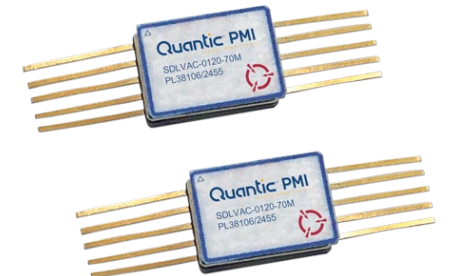

Surface Mount Designs

Detector Log Video Amplifiers (DLVAs)

Standard Off-the-Shelf Models...



**0.5 to 18 GHz
CW Immune DLVA**



0.5 to 18 GHz DLVA



0.5 to 2 GHz DLVA



2 to 4 GHz DLVA



**0.5 to 18.5 GHz
Dual Channel DLVA**



5 to 90 MHz SDLVA



5.5 to 8.5 MHz DLVA



2 to 4 GHz DLVA



4 to 8 GHz DLVA



8 to 10 GHz DLVA

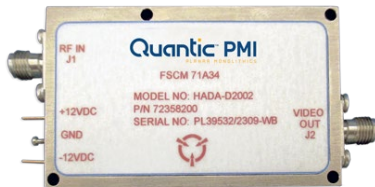

2 to 18 GHz DLVA



6 to 18 GHz DLVA



18 to 40 GHz DLVA

CW Immune DLVA, GMDA-CW0518-30



- > Designed for high-speed applications while maintaining flatness and accuracy
- > TSS Measured: -43 dBm Min (10 MHz video bandwidth)
- > Size 2.3" x 2.3" x 0.47" with SMA Female Connectors

PARAMETERS	SPECIFICATIONS
Frequency Range	0.5 to 18.0 GHz
Output Voltage Flatness	± 0.5 V Across the band
TSS	-43 dBm Min
Video Test Output	Fixed 450 mV ±100 mV
DC Offset of Test Output	+1.2 V ±10%
Impedance	Meet all requirements with 50 OHM load
Log Slope	80 mV/dB w/ ±12 mV/dB tolerance @ Input Power -40 to -10 dBm, Transition from 280 mV/dB tolerance @ Input Power -10 to 0 dBm, 0 mV/dB with ±12 mV/dB tolerance @ Input Power 0 to +20 dBm
Input Power -40 to -10 dBm	280 mV/dB with ±12 mV/dB tolerance
Input Power -10 to 0 dBm	Transition from 280 mV/dB tolerance
Input Power 0 to +20 dBm	0mV/dB with ±12 mV/dB tolerance
Log Linearity	±1.0 dB @ Input Power -40 to -10 dBm, Transition from 280 to 0 mV/dB @ Input Power -10 to 0 dBm, ±1.0 dB @ Input Power 0 to +20 dBm

DLVA, PLVA-500M18G-50



- > Employs planar diode detectors and integrated video circuitry for high-speed performance and outstanding reliability
- > Log slope of 50 mV/dB and log linearity error of less than ± 0.5 dB
- > Small compact housing measures only 2.2" x 1.5" x 0.4 with SMA Female Connectors

PARAMETERS	SPECIFICATIONS
Frequency Range	0.5 to 18.0 GHz
Frequency Flatness	± 1.0 dB Max
Logging Range	-40 to 0 dBm Min
Useful Range	-40 to +5 dBm
Log Linearity Error	± 0.5 dB Max @ 25 °C ± 1.0 dB Average (-54 °C to +85 °C)
Log Slope	50 mV/dB
Log Slope Accuracy	± 4 % of Average Slope
Temperature Stability	± 1.0 dB Max (-54 °C to +85 °C)
Pulse Response	50 ns to CW
Rise Time	20 ns Max
Settling	45 ns Max
Recovery Time	150 ns Typ, 300 ns Max
TSS	-42 dBm Min (Video BW)
VSWR	3.0:1 Max
Video Output Level	0 to 2.5 V (50 Ohm load)
Max RF INPUT	+15 dBm
DC Power Supply	± 12 VDC @ 75 mA Max

Model PLVA-500M18G-50, 0.5 to 18.0 GHz, DLVA

Performance Plots

Log Transfer vs. Frequency @ +25 °C

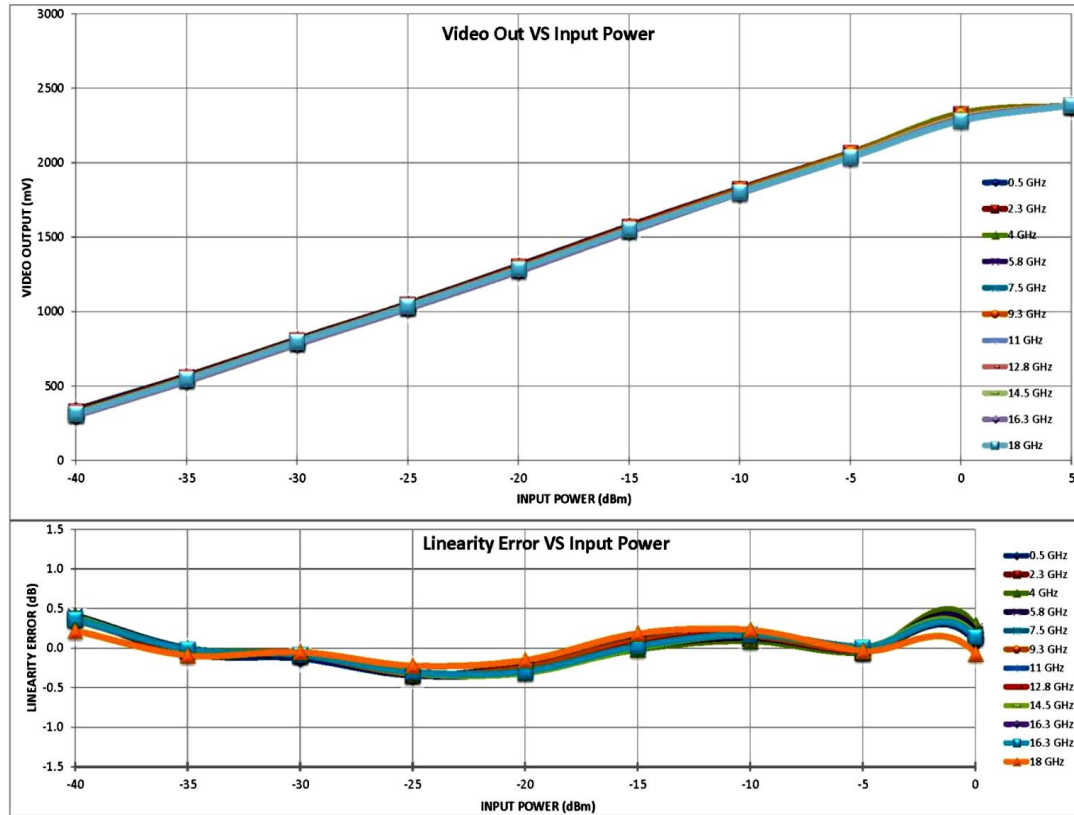

Rise / Fall & Settling Times @ +25 °C / 0 dBm IN @ 18 GHz

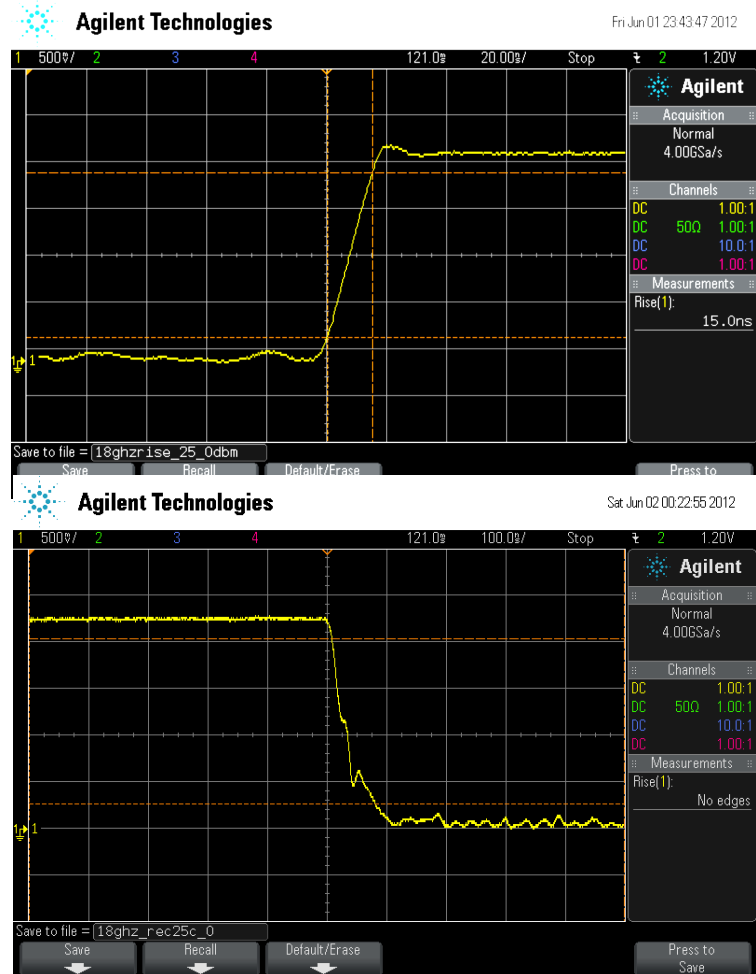

DLVA, HADA-D2001



- > Operates over 0.5 to 2.0 GHz frequency range
- > Dynamic range of 40 dB, a log slope of 50 mV/dB and a nominal bandwidth of 20 MHz
- > Designed using innovative technology which provides stunning performance and reliability
- > Compact package making it an optimum solution for high speed, channelized receiver applications
- > Unit's housing is 2.50" x 1.50" x 0.44" with SMA female connectors

PARAMETERS	SPECIFICATIONS
Frequency Range	0.5 to 2.0 GHz
TSS	-44 dBm Min @ -40 °C to +85 °C
VSWR (Input)	2.5:1 Max @ +23 sBm
Log Accuracy	±1.50 dB Max (@ 25°C , 1.0 GHz)
Log Linearity	±0.50 dB Max @ 25°C ±0.75 dB Max @ -40 °C to +85 °C
Frequency Flatness	±0.75 dB Max
Rise Time	30 ns Max (10% to 90%)
Fall Time	500 ns Max (@Pulse Width 100 µs Input)
Propagation Delay	60 ns Max
Max RF Input	+23 dBm
DC Offset	+95 mV +55/-100 mV @ +40 °C to +85 °C

DLVA, DLVA-2G4G-45-70-CD-1



- > Frequency coverage of 2 to 4 GHz
- > Dynamic range of 45 dB, a log slope of 70 mV/dB and nominal video bandwidth of 14 MHz
- > Features that can convert any incoming signal ranging from 50 ns to CW to a pulsed output of 600 ns
- > State-of-the-art design utilizes cutting edge technology which provides stunning performance and reliability
- > Compact package making it an optimum solution for high-speed channelized receiver

PARAMETERS	SPECIFICATIONS
Frequency Range	2.0 to 4.0 GHz
Input VSWR (50 Ohms)	1.92:1 (-10 dB Max)
Input Power Handling	+20 dBm Max
Video Log Range	-30 to +15 dBm
Video Log Linearity	±1.5 dB @ 25 °C
Video Log Slope	70 mV/dB ±5 mV/dB
Video Frequency Flatness	±1.5 dB
Pulse Width Range *	80 ns to CW
Video Output Impedance	100 Ohms
Video Rise Time	35 ns Max
Video Fall Time	200 ns Max
Recovery Time	1.0 µs Max
Settling Time	60 ns Max
Video Output Pulse Width	600 ns ±200 ns
Video Output Noise	60 mV p-p

* (50 ns with little degradation in performance)
(PW less than 40 ns will not trigger an output)

Dual Channel DLVA, DLVA-50M18D5G-40-LIN-LOG-CD-1



PARAMETERS	SPECIFICATIONS
Frequency Range	0.5 to 18.5 GHz
TSS	-40 dBm
Frequency Flatness	±2 dB Max LO (Low Band) ±1.5 dB Max HI (High Band)
Dynamic Range	-40 to 0 dBm
Log Linearity	+/-0.5 dB (Up to -15 dBm) +/-1.0 dB (Up to -10 dBm)
Rise Time	100 ns Max LO (Low Band) 25 ns Max HI (High Band)

- > Operates between 50 MHz to 750 MHz (LO) and 0.75 to 18.5 GHz (HI) frequency ranges
- > Employs planar diode detectors and integrated video circuitry for high-speed performance and outstanding reliability
- > Superior construction and uses state-of-the-art MIC technology
- > Package size 4.0" x 3.0" x 1.0" with SMA female connectors

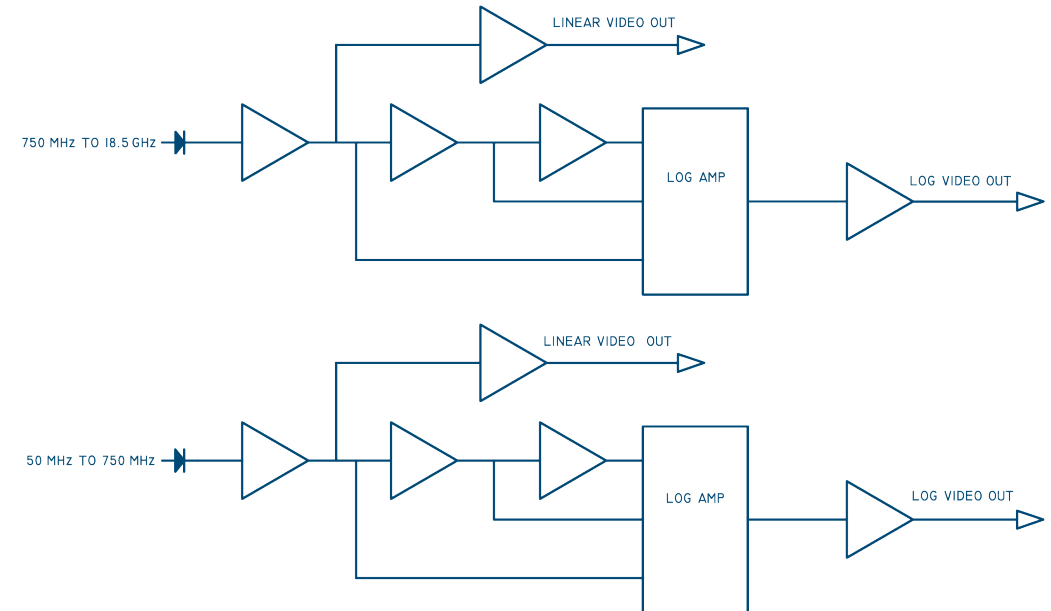

SDLVA, DLVA-70M-80-15V



- > Operates over the 50 to 90 MHz frequency range
- > Dynamic range of 80 dB typical, with a nominal video bandwidth of 40 MHz and a fast rise time of 30 ns
- > Designed using monolithic technology which provides stunning performance and reliability
- > Compact package, making it an optimum solution high-speed channelized receiver applications

PARAMETERS	SPECIFICATIONS
Frequency Range	0.05 to 0.09 GHz
Input VSWR (50 Ohms)	Input: 1.5:1 Typ Output: 2.0:1 Typ
Input Power Handling	+13 dBm Max
Logging Range	-80 to 0 dBm
Log Linearity	±1.5 dB Max (-80 to 0 dBm)
Limited IF Output	0 dbm Nom
Dynamic Range	-80 to 0 dBm
Video Rise Time	30 ns Max
Video Fall Time	200 ns Max
Recovery Time	1.0 μs Max

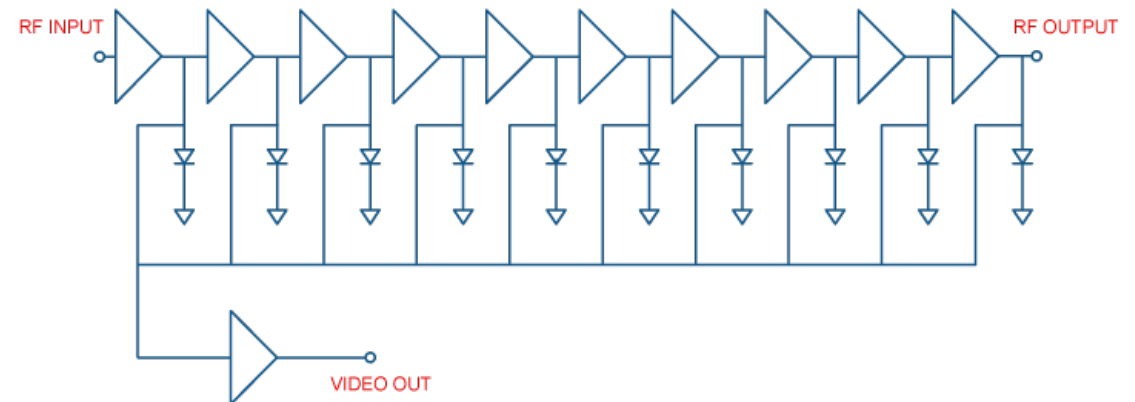

Low Frequency DLVA, DLVA-7M-80-SFF



- > Frequency range 5.5 to 8.5 MHz
- > Bandwidth is 3 MHz minimum with typical Logging Range from -80 dBm to 0 dBm.
- > Output sensitivity of this unit is typically 25 mV/dB
- > Package size 4.0" x 3.0" x 1.0" with SMA female connectors

PARAMETERS	SPECIFICATIONS
Frequency Range	5.5 to 8.5 MHz
Log Slope	25 mV/dB Nom
Log Linearity	±1.0 dB Max
TSS	-80 dBm
Dynamic Range	-70 dB Min, 80 dB Typ
Output Voltage	0.2 to 2.0 V (-70 to 0 dBm Input)
Rise Time	360 ns Max
Input Logging Range	-80 to 0 dBm

DLVA, SDLVA-218-44-70MV



- > Operates over the 2 to 18 GHz frequency range
- > Logging range of -40 to +4 dBm having a log slope of 70 mV/dB; logging linearity is better than ± 0.75 dB; the rise time is 25 ns Max and fall time 300 ns Max
- > This model operates on ± 15 VDC and is supplied in a small housing measuring only 2.2" x 1.5" x 0.4"

PARAMETERS	SPECIFICATIONS
Frequency Range	2.0 to 18.0 GHz
Logging Range	-40 to +4 dBm
TSS	-42 dBm Max
Logging Slope	+70 ± 3 mV/dB Max
Logging Linearity @ +25C	± 0.75 dB Max (-40 to 0 dBm)
Flatness	± 1.5 dB Max
Max Input Power	+20 dBm
Video Load Impedance	50 ohms
Video Rise Time	25 ns Max
Video Fall Time	300 ns Max
Recovery Time	500 ns Max
Pulse Width Range	50 ns to CW Min
DC Offset at RF Terminated	± 70 mV Max
Noise at RF Terminated	150 mV P-P Max
Mode	DC Coupled



- > 4 to 8 GHz operating frequency range
- > Dynamic range of -55 dBm to +5 dBm with a minimum TSS of -60 dBm; a log slope of 25.0 ±1.0 mV/dB; and a nominal video bandwidth of 33 MHz
- > Designed using innovative technology which provides optimum performance and reliability in a making it an optimum solution for high-speed channelized receiver applications
- > Compact package 1.80" x 1.00" x 0.28" with SMA female connectors

PARAMETERS	SPECIFICATIONS
Frequency Range	4.0 to 8.0 GHz
VSWR	2.0:1 Max
Log Slope	25 ± 1 mV/dB Nom
Logging Range	-55 to +5 dBm
TSS	-60 dBm Min
Max Input Power	+23 dBm CW
Video Load Linearity	+1.85 dB over temperature
Video Log Slope	25 ± 1 mV/dB Nom
Video Frequency Flatness	±2 dB Max
Recovery Time	100 ns Max
Rise Time	30 ns Max
Fall Time	80 ns Max
Video Output Load Impedance	75 Ohm



- > 2 to 18 GHz frequency coverage
- > Dynamic range of 40 dB with a log slope of 50 mV/dB and nominal video bandwidth of 12 MHz
- > Designed with cutting-edge technology which provides stunning performance a high reliability making it an optimum solution for high-speed channelized receiver applications
- > Compact package size 2.50" x 1.50" x 0.44" with SMA female connectors.

PARAMETERS	SPECIFICATIONS
Frequency Range	2.0 to 18.0 GHz
TSS	-40 dB Min (Video In)
VSWR (Input)	3.0:1 Max
Logging Range	-40 to 0 dBm
Log Accuracy	±1.50 dB Max @ 25°C
Log Linearity	±0.50 dB Max
Frequency Flatness	±1.65 dB Max
Rise Time	30 ns Max
Fall Time	100 ns Max
Propagation Delay	60 ns Max
Max RF Input	+23 dBm
DC Offset	+95 mV +55/-100 mV @ +40 °C to +85 °C
Dimensions	2.5" X 1.5" X 0.44", 150 grms

DLVA, DLVA-6D5G18G-70-JMAKG2



- > Operates over 6.5 to 18 GHz frequency range
- > Designed for high-speed applications while maintaining flatness and accuracy
- > Package size of 3.2 " x 2.05 " x 0.4" with SMA female connectors

PARAMETERS	SPECIFICATIONS
Frequency Range	6.5 to 18.0 GHz
TSS	-72 dBm Max
Log Slope	25 mv/dB ($\pm 10\%$) @ 50 Ω Load
Log Range	-70 to 0 dBm
Log Linearity	± 1.5 dB Typ, ± 1.75 dB Max
Log Accuracy	± 2.0 dB Max
Recovery Time	<70 ns @ -10 dBm
VSWR	3.0:1 Max
Max Input Power	+20 dBm CW Max
Pulse Range	100 ns to CW
Video Output Level	0 to 2.2 VDC (50 Ω Load)
Overshoot	1 dB Max
Max Video Output	2.4 V
Pulse Rise Time (10 % to 90 %)	<30 ns
Pulse Overshoot	0.0 dB with 50 Ω Load
Pulse Fall Time (10 % to 90 %)	<70 ns
Propagation Delay Time	<15 ns

DLVAs, DLVA-8G10G-75-50-SFF & DLVA-8G10G-75-50-SFF-2



- > Frequency coverage 8.0 to 10.0 GHz
- > Dynamic range of -75 dBm to 0 dBm (DLVA-8G10G-75-50-SFF) & -70 dBm to +5 dBm (DLVA-8G10G-75-50-SFF-2), log linearity of ± 1.8 dB, and log slope of 50 ± 4 mV/dB
- > Finish is Electroless Nickel Plate 0.0005 to 0.0007 THK Per AMS 2404.
- > Package size is 2.00" x 1.50" x 0.40" with SMA female connectors

PARAMETERS	SPECIFICATIONS	
Model No.	DLVA-8G10G-75-50-SFF	DLVA-8G10G-75-50-SFF-2
Frequency Range	8.0 to 10.0 GHz	8.0 to 10.0 GHz
TSS	-78 dBm	-73 dBm
Log Slope	50 ± 4 mV/dB	50 ± 4 mV/dB
Log Range	-75 to 0 dBm	-70 to +5 dBm
Log Linearity	± 1.8 dB	± 1.8 dB
Rise Time	30 ns Max	30 ns Max
Fall Time	150 ns Max	150 ns Max
Recovery Time	500 ns for 10 μ s PW	500 ns for 10 μ s PW
Frequency Flatness	± 1.8 dB	± 1.2 dB
Dynamic Range	-75 to 0 dBm	-70 to +5 dBm

Model HADA-D2002, 2.0 to 18.0 GHz, DLVA

Performance Plots

Frequency	INTERCEPT (mV)	SLOPE (mV/dB)
2 GHz	2167	51.2

Frequency	INTERCEPT (mV)	SLOPE (mV/dB)
6 GHz	2194	51

Frequency	INTERCEPT (mV)	SLOPE (mV/dB)
10 GHz	2164	50.9

Frequency	INTERCEPT (mV)	SLOPE (mV/dB)
14 GHz	2183	50.4

Frequency	INTERCEPT (mV)	SLOPE (mV/dB)
18 GHz	2160	49.5

Flatness +/- dB
Max Video Output Volts
Min Video Output Volts

	-36	-31	-26	-21	-16	-11	-6	-1	4
328	584	829	1072	1347	1621	1864	2125	2359	
5	5	-5	-20	-1	17	4	9	-13	
0.09	0.09	-0.13	-0.38	-0.01	0.34	0.08	0.18	-0.26	
-0.44	-0.32	-0.42	-0.56	-0.06	0.42	0.28	0.50	0.18	
360	617	865	1108	1378	1652	1890	2151	2383	
1	3	-4	-15	0	19	2	8	-14	
0.02	0.06	-0.07	-0.30	0.00	0.37	0.04	0.16	-0.28	
0.20	0.34	0.30	0.16	0.56	1.04	0.80	1.02	0.66	
335	593	840	1082	1343	1617	1863	2123	2358	
2	0	-2	-14	-7	12	4	9	-10	
0.04	0.11	-0.03	-0.28	-0.15	0.24	0.07	0.18	-0.20	
-0.30	-0.14	-0.20	-0.36	-0.14	0.34	0.26	0.46	0.16	
368	622	871	1113	1372	1644	1885	2140	2370	
0	2	-1	-11	-4	16	5	8	-14	
0.00	0.04	-0.02	-0.22	-0.08	0.31	0.10	0.16	-0.28	
0.36	0.44	0.42	0.26	0.44	0.88	0.70	0.80	0.40	
373	625	877	1118	1364	1634	1870	2117	2338	
-6	-2	3	-3	-4	18	7	7	-20	
-0.13	-0.03	0.06	-0.06	-0.09	0.37	0.14	0.13	-0.40	
0.46	0.50	0.54	0.36	0.28	0.68	0.40	0.34	-0.24	
0.30	0.30	0.40	0.40	0.30	0.30	0.30	0.30	0.20	
0.37	0.63	0.88	1.12	1.38	1.65	1.89	2.15	2.38	
0.33	0.58	0.83	1.07	1.34	1.62	1.86	2.12	2.34	

RF Input Power (dBm)	
Measured Value (mV)	Error(dB)
Error (mV)	MAX MIN
LINEARITY ERROR (dB)	0.34 -0.38
LOGGING ACCURACY (dB)	0.50 -0.56

RF Input Power (dBm)	
Measured Value (mV)	Error(dB)
Error (mV)	MAX MIN
LINEARITY ERROR (dB)	0.37 -0.30
LOGGING ACCURACY (dB)	1.04 0.16

RF Input Power (dBm)	
Measured Value (mV)	Error(dB)
Error (mV)	MAX MIN
LINEARITY ERROR (dB)	0.24 -0.28
LOGGING ACCURACY (dB)	0.46 -0.36

RF Input Power (dBm)	
Measured Value (mV)	Error(dB)
Error (mV)	MAX MIN
LINEARITY ERROR (dB)	0.31 -0.28
LOGGING ACCURACY (dB)	0.88 0.26

RF Input Power (dBm)	
Measured Value (mV)	Error(dB)
Error (mV)	MAX MIN
LINEARITY ERROR (dB)	0.37 -0.40
LOGGING ACCURACY (dB)	0.68 -0.24

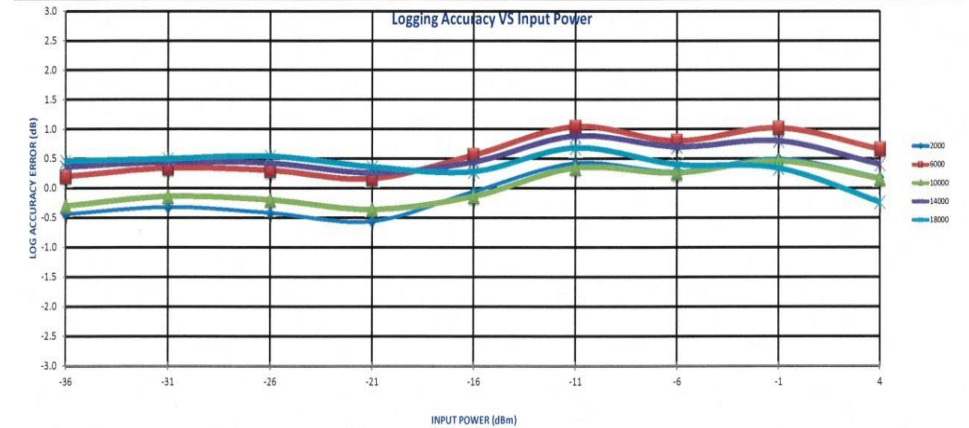
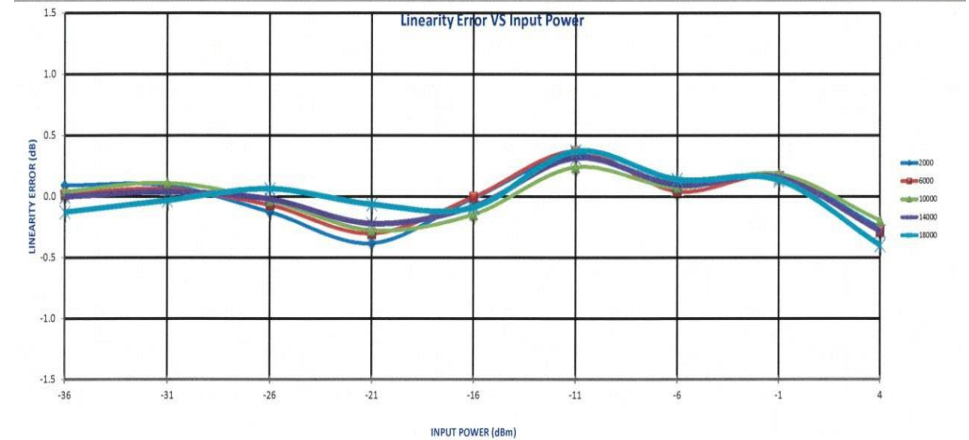

DLVA, DLVA-18G40G-42-50-CD-1



- > Operating frequency range of 18 to 40 GHz with performance optimized in the range of 30 to 31 GHz
- > Features a 42 dB logging range
- > Housed in a hermetic package of 1.86" x 1.69" x 0.40" with 2.92mm female connectors

PARAMETERS	SPECIFICATIONS
Frequency Range	18.0 to 40.0 GHz (Operational) 30.0 to 31.0 GHz (Full Performance)
Flatness @ -23 dBm	±0.25 dB - Measured ±0.1 dB
VSWR (In/Out)	1.5:1 Max - Measured 1.18
TSS	-34 dBm - Measured -39.8 dBm
Logging Range	-32 to +10 dBm
Log Slope	50 mV/dB ±3 dB - Measured +51.83 mV/dB
Log Linearity	±0.5 dB - Measured +0.4, -0.35 dB
DC Offset	0 to ±75 mV - Measured +45 / -4 mV
Output Stability (-54 to +85 °C)	±0.75 dB - Measured ±0.29 dB
Output Polarity	Positive
Rise Time (TSS + 10 dB)	1000 ns
Recovery Time	100 µs
Video Load	100 Ohms

Extended Range Detector Log Video Amplifiers (ERDLVAs)

Standard Off-the-Shelf Models...



0.46 to 2 GHz, ERDLVA



2 to 6 GHz, ERDLVA



2 to 6 GHz,
CW Immune, EW
Detector Module



2 to 8 GHz
CW Immune ERDLVA



2 to 18 GHz, ERDLVA



2 to 18 GHz
CW Immune ERDLVA



2 to 18 GHz,
CW Immune ERDLVA



2 to 18 GHz,
CW Immune ERDLVA



5.4 to 5.9 GHz,
Digital ERDLVA



6 to 18 GHz
Hermetically Sealed
ERDLVA



6 to 18 GHz,
CW Immune, EW
Detector Module



8 to 18 GHz
CW Immune ERDLVA

ERDLVA, GMDA-D1005, GMDA-D1006, GMDA-D1007



- > Broadband frequency coverage.
- > Designed using cutting edge technology which provides stunning performance and reliability, making it an optimum solution for high speed, channelized receiver applications.
- > Package size of 3.50" x 3.20" x 0.50" with SMA female connectors

PARAMETERS	SPECIFICATIONS		
	GMDA-D1005	GMDA-D1006	GMDA-D1007
Model	GMDA-D1005	GMDA-D1006	GMDA-D1007
Frequency Range	0.46 to 1.1 GHz	2.0 to 6.0 GHz	0.5 to 2.0 GHz
Logging Range	-60 to -10 dBm	-60 to -10 dBm	-60 to +7 dBm
TSS	-65 dBm Max	-65 dBm Min	-65 dBm Max
Logging Slope	+25.0±1.0 mV/dB Typ	+25.0±1.0 mV/dB Room Temp	+25.0±1.0 mV/dB Room Temp
Logging Linearity	±1.0 dB / ±1.5 dB Over Temperature	±1.50dB @ Room Temperature ±1.5 dB Max. Over Temperature	±1.5 dB @ Room Temperature ±2.0 dB Over Temperature
Flatness	50 mV Max	50 mV Max.	100 mV Max
RF Safe Input Power	+23 dBm Max CW	+23 dBm Max.	+23 dBm Max CW
Max Output Voltage	+2.5 V Max	+2.5 V Max.	+2.5 V Max
Input VSWR (50 Ω)	2.0:1 Max	2.0:1 Max	2.3:1 Max
Video Load Impedance	75 Ω Nom	75 Ω Typ.	75 Ω Typ
Video Rise Time	30 ns Max	30 ns Max.	30 ns Max
Recovery Time	500 ns Max	1 μs	1 μs Max
Throughput Time	30 ns Max	30 ns Max.	30 ns Max
Video Bandwidth	10 MHz Typ	10 MHz Typ.	10 MHz Typ
Offset Voltage	±50 mV Max	±50 mV Max.	±50 mV Max

ERDLVA GMDA-2G6G-50MV



- > 2.0 to 6.0 GHz Frequency Coverage
- > Logging range of -6 to +10 dBm & minimum TSS of -65 dBm
- > Employs planar diode detectors and integrated video circuitry for high-speed performance and outstanding reliability
- > Superior construction using state of the art MIC technology
- > Package size of 3.50" x 3.20" x 0.50" with an SMA female connector

PARAMETERS	SPECIFICATIONS
Frequency Range	2.0 to 6.0 GHz
TSS	-65 dBm Min
Input VSWR (50 Ω)	2.0:1 Max
Logging Range	-60 to +10 dBm
Log Linearity	±1.0 dB @ Room Temperature ±1.5 dB Max Over Room Temperature
Logging Slope	+50±2 mV/dB @ Room Temperature +50±3 mV/dB Over Temperature +50 mV Typ
Flatness	100 mV Max
RF Safe Input Power	+23 dBm Max CW (Without Damage)
Maximum Output Voltage	+4.2 V Max
Video Load Impedance	Twisted Pair into 100 Ω
Video Rise Time	30 ns Max
Recovery Time	500 ns
Throughput Time	30 ns Max
Video Bandwidth	10 MHz Typ
Offset Voltage	±100 mV Max

CW Immune ERDLVA, ERDLVA-2G8G-65-70MV



TSS @ -71 dBm

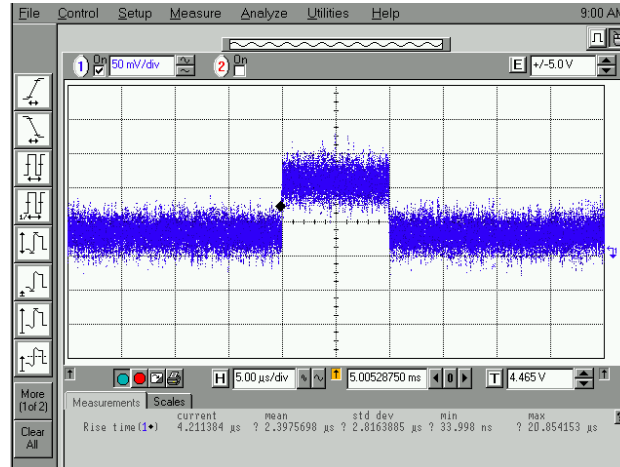

- > 2.0 to 8.0 GHz frequency range
- > Features an internal switch used to switch between the "Bit In" and RF In" with input blanking on both ports
- > Video output is designed to drive a 100 ft. cable, while maintaining high speed, and excellent accuracy
- > Package size of 2.82" x 2.25" x 0.5" with SMA female connectors

PARAMETERS	SPECIFICATIONS
Frequency Range	2.0 to 8.0 GHz
VSWR	2.3:1 Max @ 50 Ω
Input Power Max	(1) 1 W CW (2) 100 W Peak @ PW = 1 μs & Duty Cycle = 1%
Switch Isolation	60 dB Min (All Ports)
Switching Speed	100 ns Max
Video Frequency Flatness	±1.25 dB Max @ 25°C
TSS	-71 dBm
Dynamic Range	-65 to 0 dBm
Log Slope	70 mV/dB ±3 mV/dB
Log Linearity	±1.0 dB Max
Log Accuracy @ 25°C	±1.25 dB Max
Absolute Log Accuracy	±2.0 dB Max
Video Output @ -65 dBm	330 ±88 mV Over Frequency
Video Output Drive Capability	Driving 100 ft RG180 into 95 Ω
Propagation Delay	80 ns Max (50% RF to 10% Video)
CW Immune Power	TSS to -40 dBm
CW Immune Time @ CW = -40 dBm	4 ms Max
CW Recovery Time @ CW = -40 dBm	120 μs
Baseline Shift	200 mV Max @ -40 dBm CW
Pulse Amplitude Lose with Pulse @ -30 dBm	CW @ -50 dBm = No Loss CW @ -40 dBm = 2 dB Max
CW Immune Time @ CW = -40 dBm	4 ms Max

CW Immune ERDLVA-8G18G-65-70MV



TSS @ -71 dBm

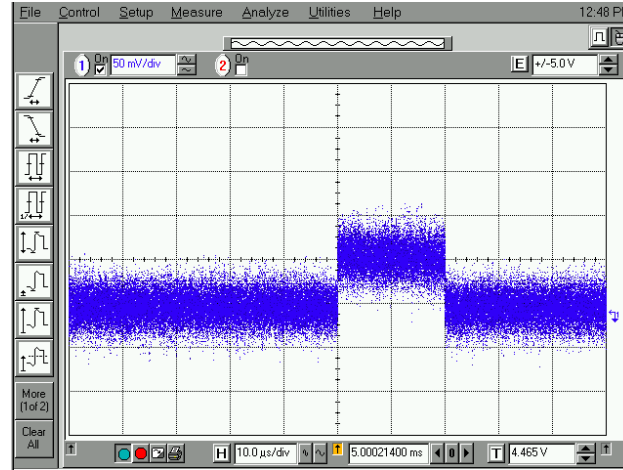

- > 8.0 to 18.0 GHz frequency range
- > Features an internal switch used to switch between the "Bit In" and RF In" with input blanking on both ports
- > Video output is designed to drive a 100 ft. cable, while maintaining high speed, and excellent accuracy
- > Package size of 2.82" x 2.25" x 0.5" with SMA female connectors

PARAMETERS	SPECIFICATIONS
Frequency Range	8.0 to 18.0 GHz
VSWR	2.3:1 Max @ 50 Ω
Input Power Max	(1) 1 W CW (2) 100 W Peak @ PW = 1 μs & Duty Cycle = 1%
Switch Isolation	60 dB Min (All Ports)
Switching Speed	100 ns Max
Video Frequency Flatness	±1.75 dB Max @ 25°C
TSS	-71 dBm
Dynamic Range	-65 to 0 dBm
Log Slope	70 mV/dB ±3 mV/dB
Log Linearity	±1.0 dB Max
Log Accuracy @ 25°C	±1.25 dB Max
Absolute Log Accuracy	±2.0 dB Max
Video Output @ -65 dBm	330 ± 88 mV Over Frequency
Video Output Drive Capability	Driving 100 ft RG180 into 95 Ω
Propagation Delay	80 ns Max (50% RF to 10% Video)
CW Immune Power	TSS to -40 dBm
CW Immune Time @ CW = -40 dBm	4 ms Max
CW Recovery Time @ CW = -40 dBm	120 μs
Baseline Shift	200 mV Max @ -40 dBm CW
Pulse Amplitude Lose with Pulse @ -30 dBm	CW @ -50 dBm = No Loss CW @ -40 dBm = 2 dB Max
CW Immune Time @ CW = -40 dBm	4 ms Max

ERDLVA, GMDA-D1003 & GMDA-D1004



- > Broadband frequency coverage
- > Designed using planar diode detectors and integrated video circuitry for high-speed performance and outstanding reliability
- > Superior construction using state of the art MIC technology makes it an optimum solution for high-speed channelized receiver applications
- > Package size of 3.50" x 3.20" x 0.50" with SMA female connectors

PARAMETERS	SPECIFICATIONS	
Model No.	GMDA-1003	GMDA-1004
Frequency Range	7.0 to 18.0 GHz	2.0 to 18.0 GHz
Logging Range	-70 to +5 dBm	-60 dBm to +7 dBm
TSS	-75 dBm Max	-65 dBm Max
Log Slope	+25.0 ± 1.0 mV/dB Max	+25.0 ± 1.0 mV/dB Max
Log Linearity	±1.0 dB Max @ +25 °C ±1.2 dB Max @ -25 °C & +85 °C	±1.5 dB Max at Room Temp
Flatness	100 mV Max	100 mV Max
RF Safe Input Power	+23 dBm Min	+23 dBm Min
Max Output Voltage	+2.5 V Max	+2.5 V Max
Input VSWR (50 Ω)	2.5:1 Max	2.3:1 Max
RF Input Impedance	50 Ω Nom	50 Ω Nom
Video Load Impedance	75 Ω Nom	75 Ω Nom
Video Rise Time	30 ns Max	30 ns Max
Recovery Time	1 μs Max	1 μs Max
Throughput Time	30 ns Max	30 ns Max
Video Bandwidth	10 MHz Min	10 MHz Min
Offset Voltage	+50 mV Max	+50 mV Max

CW Immune ERDLVA, ERDLVA-218-CW-LPD-100



- > Designed for ultra-low DC power consumption
- > Operates over the 2 to 18 GHz frequency range and offers a log slope of 77 mV/dB into a 100 Ohm video load
- > Provides extremely high speed, excellent flatness and accuracy
- > Ultra-small hermetically sealed housing measuring only 2.04" x 1.67" x 0.472" with an SMA female connector

PARAMETERS	SPECIFICATIONS
Frequency Range	2.0 to 18.0 GHz
Frequency Flatness	±2.0 dB Max
TSS	-64 dBm Min
Max Noise	10.0 mV RMS with input terminated
VSWR:	2.0:1 Max
Max Input Power (No Damage)	+30 dBm CW +50 dBm Peak Pulse, 1% Duty Cycle, 10 μs
Log Slope	77 mV/dB (±5 mV) into a 100 Ohm Load
Video Output Range	-0.5 V (-60 dBm) < RF IN < 5.5 V (4 dBm)
DC Offset	±150 mV
Log Range	-60 to +4 dBm Min
Log Linearity	±1.5 dB (-20 °C to +85 °C) Max ±1.75 dB (-54 °C to +95 °C) Max
Pulse Range	200 ns to 20 μs
Propagation Delay	30 ns
Rise Time	35 ns Max (20 ns Typ)
Settling Time to ±1dB	50 ns
Recovery Time	500 ns Max (200 ns Typ)
Duty Cycle	80% at Max pulse width 50% at Minimum pulse width
CW Immunity Range	TSS to -40 dBm
Pulse Considered "CW"	900 μs
Baseline Shift	25 mV Max
Rejection Time	1 ms
Droop	1 dB Max

CW Immune ERDLVA, ERDLVA-218-CW-LPD-100

Performance

ISO 9001:2000 CERTIFIED

Frequency

2 GHz INTERCEPT (mV) -5093
SLOPE (mV/dB) -76.4

RF Input Power (dBm)	-65	-60	-55	-50	-45	-40	-35	-30	-25	-20	-15	-10	-5	0	4
Measured Value (mV)	71	-528	-889	-1294	-1679	-2048	-2412	-2756	-3139	-3547	-3939	-4329	-4691	-5168	-5402
Error (mV)	199	-18	2	-20	-23	-10	8	46	44	19	8	0	20	-74	-3
LINEARITY ERROR (dB)	-2.61	0.23	-0.03	0.26	0.30	0.13	-0.10	-0.60	-0.58	-0.24	-0.11	0.00	-0.26	0.97	0.03

RF Input Power (dBm)

Measured Value (mV)
Error (mV)
LINEARITY ERROR (dB)

4 GHz INTERCEPT (mV) -5145
SLOPE (mV/dB) -76.3

RF Input Power (dBm)	-65	-60	-55	-50	-45	-40	-35	-30	-25	-20	-15	-10	-5	0	4
Measured Value (mV)	66	-579	-939	-1339	-1727	-2110	-2462	-2829	-3198	-3615	-4017	-4385	-4759	-5220	-5403
Error (mV)	252	-11	10	9	-15	-17	13	28	40	4	-17	-3	5	-75	47
LINEARITY ERROR (dB)	-3.30	0.15	-0.13	0.12	0.19	0.22	-0.17	-0.36	-0.52	-0.05	0.22	0.04	-0.06	0.98	-0.62

Measured Value (mV)
Error (mV)
LINEARITY ERROR (dB)

6 GHz INTERCEPT (mV) -5087
SLOPE (mV/dB) -76.1

RF Input Power (dBm)	-65	-60	-55	-50	-45	-40	-35	-30	-25	-20	-15	-10	-5	0	4
Measured Value (mV)	60	-535	-892	-1297	-1681	-2058	-2421	-2766	-3145	-3556	-3949	-4335	-4686	-5150	-5377
Error (mV)	201	-13	10	-14	-18	-15	3	38	40	9	-3	9	21	-63	14
LINEARITY ERROR (dB)	-2.65	0.18	-0.13	0.18	0.23	0.20	-0.04	-0.51	-0.52	-0.12	0.05	0.12	-0.27	0.83	-0.18

Measured Value (mV)
Error (mV)
LINEARITY ERROR (dB)

8 GHz INTERCEPT (mV) -5125
SLOPE (mV/dB) -75.9

RF Input Power (dBm)	-65	-60	-55	-50	-45	-40	-35	-30	-25	-20	-15	-10	-5	0	4
Measured Value (mV)	58	-590	-947	-1343	-1725	-2103	-2454	-2817	-3186	-3599	-3995	-4369	-4732	-5201	-5403
Error (mV)	250	-18	4	-12	-14	-13	16	32	42	9	-7	-2	14	-75	25
LINEARITY ERROR (dB)	-3.30	0.23	-0.06	0.15	0.19	0.17	-0.21	-0.42	-0.55	-0.12	0.10	0.03	-0.18	0.99	-0.34

Measured Value (mV)
Error (mV)
LINEARITY ERROR (dB)

10 GHz INTERCEPT (mV) -5086
SLOPE (mV/dB) -76.2

RF Input Power (dBm)	-65	-60	-55	-50	-45	-40	-35	-30	-25	-20	-15	-10	-5	0	4
Measured Value (mV)	55	-533	-889	-1287	-1668	-2038	-2412	-2768	-3145	-3552	-3938	-4328	-4676	-5144	-5398
Error (mV)	185	-22	4	-13	-13	-1	5	31	35	9	4	4	29	58	-7
LINEARITY ERROR (dB)	-2.42	0.28	-0.05	0.17	0.17	0.02	-0.07	-0.40	-0.46	-0.12	-0.05	0.05	-0.38	0.76	0.09

Measured Value (mV)
Error (mV)
LINEARITY ERROR (dB)

12 GHz INTERCEPT (mV) -5047
SLOPE (mV/dB) -75.8

RF Input Power (dBm)	-65	-60	-55	-50	-45	-40	-35	-30	-25	-20	-15	-10	-5	0	4
Measured Value (mV)	58	-515	-873	-1272	-1652	-2026	-2399	-2731	-3117	-3518	-3901	-4294	-4628	-5087	-5384
Error (mV)	178	-16	5	-15	-16	-11	-5	41	35	13	9	5	39	40	-34
LINEARITY ERROR (dB)	-2.35	0.21	-0.07	0.19	0.21	0.15	0.07	-0.55	-0.46	-0.17	-0.11	0.06	-0.52	0.53	0.45

Measured Value (mV)
Error (mV)
LINEARITY ERROR (dB)

14 GHz INTERCEPT (mV) -5152
SLOPE (mV/dB) -76.1

RF Input Power (dBm)	-65	-60	-55	-50	-45	-40	-35	-30	-25	-20	-15	-10	-5	0	4
Measured Value (mV)	52	-603	-962	-1355	-1739	-2120	-2472	-2840	-3207	-3618	-4012	-4382	-4758	-5227	-5443
Error (mV)	255	-19	2	-10	-14	-13	15	28	41	11	-2	9	13	-75	14
LINEARITY ERROR (dB)	-3.35	0.25	-0.03	0.14	0.18	0.18	-0.20	-0.36	-0.54	-0.15	0.02	-0.12	-0.17	0.98	-0.18

Measured Value (mV)
Error (mV)
LINEARITY ERROR (dB)

16 GHz INTERCEPT (mV) -5203
SLOPE (mV/dB) -77.6

RF Input Power (dBm)	-65	-60	-55	-50	-45	-40	-35	-30	-25	-20	-15	-10	-5	0	4
Measured Value (mV)	53	-570	-927	-1328	-1716	-2094	-2480	-2866	-3231	-3641	-4042	-4412	-4818	-5291	-5466
Error (mV)	211	-23	7	-5	-6	5	6	9	31	9	-3	14	-3	-89	47
LINEARITY ERROR (dB)	-2.72	0.30	-0.10	0.07	0.07	-0.06	-0.08	-0.11	-0.40	-0.12	0.04	-0.19	0.04	1.14	-0.61

Measured Value (mV)
Error (mV)
LINEARITY ERROR (dB)

18 GHz INTERCEPT (mV) -5180
SLOPE (mV/dB) -78.4

RF Input Power (dBm)	-65	-60	-55	-50	-45	-40	-35	-30	-25	-20	-15	-10	-5	0	4
Measured Value (mV)	53	-501	-868	-1268	-1645	-2027	-2451	-2826	-3198	-3607	-4014	-4382	-4778	-5258	-5455
Error (mV)	140	-22	2	-6	9	19	-13	4	23	7	-9	14	10	-78	39
LINEARITY ERROR (dB)	-1.79	0.28	-0.03	0.07	-0.12	-0.24	0.17	-0.04	-0.30	-0.08	0.11	-0.18	-0.13	0.99	-0.49

Measured Value (mV)
Error (mV)
LINEARITY ERROR (dB)

Flatness ± dB

RF Input Power (dBm)	-65	-60	-55	-50	-45	-40	-35	-30	-25	-20	-15	-10	-5	0	4
Flatness ± dB	-0.1	-0.7	-0.6	-0.6	-0.6	-0.6	-0.5	-0.9	-0.7	-0.8	-0.9	-0.8	-1.2	-1.3	-0.6
Flatness ± dB	62	-603	-862	-1355	-1739	-2120	-2480	-2866	-3231	-3641	-4042	-4412	-4818	-5291	-5466
Flatness ± dB	71	-601	-868	-1268	-1645	-2026	-2399	-2731	-3117	-3518	-3901	-4294	-4628	-5087	-5384

Average Slope -76.5
Max Slope -75.8
Min Slope -78.4

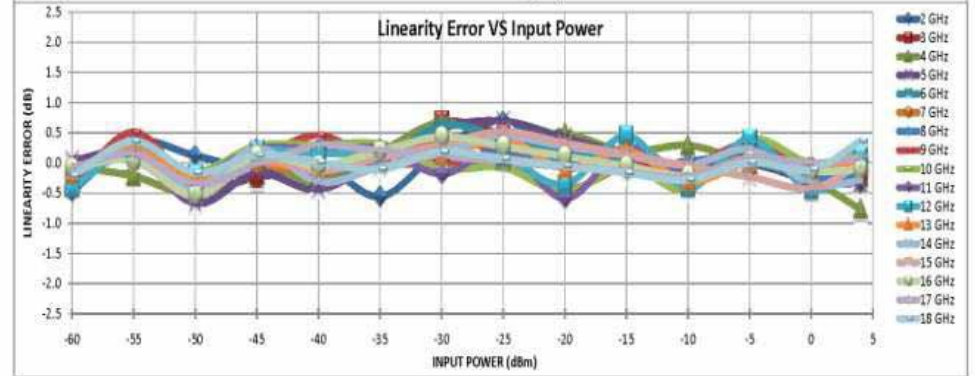
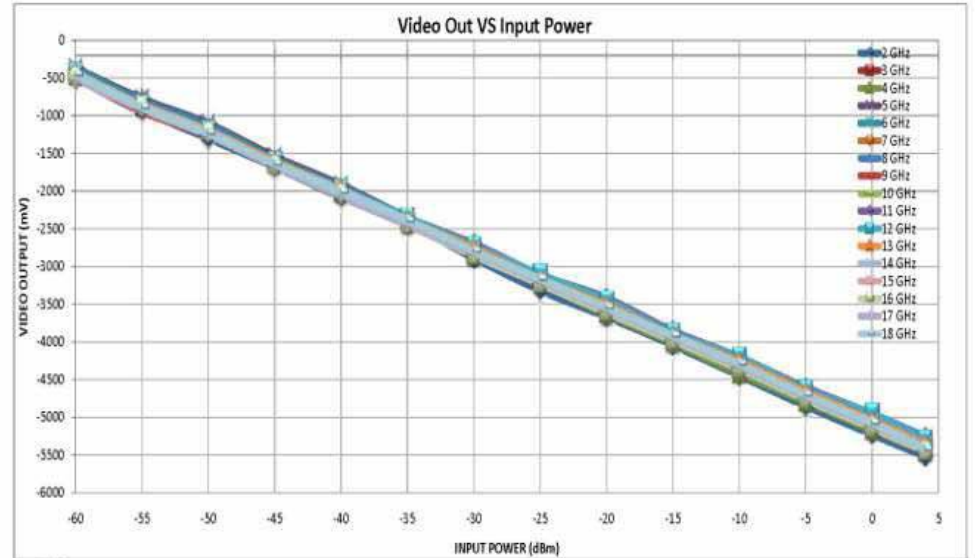

ERDLVA-218-CW-LPD-100 Into a 100 Ohm Load Tabulated Data

ERDLVA-218-CW-LPD-100 Into a 100 Ohm Load

Hermetically Sealed ERDLVA, DLVA-6G18G-50-HERM



- > Operating frequency range of 6 to 18 GHz
- > Minimum TSS of -72 dB and provides a logging range of -70 to 0 dBm; log slope is 25 mV/dB with a log accuracy of ± 4 dB maximum
- > Pulse range is 100 ns to CW and rise time is 50 ns maximum and fall time of 70 ns maximum
- > Recovery time is less than 70 ns with a delay of <15 ns.
- > Supplied in a housing measuring 3.20" x 2.05" x 0.40" and is designed to be hermetically sealed

PARAMETERS	SPECIFICATIONS
Frequency Range	6.0 to 18.0 GHz
TSS	-72 dB Min (Video In)
VSWR	2.0:1 Max
Video Output Range	0 to 2.2 VDC (50 Ohm Load)
Max Video Output	2.4 VDC
Input Power	+20 dBm CW Max
Logging Range	-70 to 0 dBm
Logging Accuracy	± 4.0 dB Max
Log Slope	25 mV/dB ($\pm 10\%$)
Log Slope Intercept Point	At -70 dBm RF Input, Output Voltage = 350 mV
Pulse Range	100 ns to CW
Pulse Rise Time (10% to 90%)	50 ns Max
Pulse Overshoot	1 dB Max
Pulse Fall Time (90% to 10%)	70 ns Max
Recovery Time	70 ns Max
Delay Time	15 ns Max

Digital ERDLVA GMDA-D5459-70



- > 5.4 to 5.9 GHz operating frequency range
- > 10 Bit digital output
- > Analog output port that is a direct representation of the digital output port with a video bandwidth of >10 MHz
- > Designed using cutting edge technology which provides stunning performance and reliability making it an optimum solution for high-speed channelized receiver applications required a digital response
- > Package size of 2.82" x 2.25" x 0.5" with SMA female connectors for RF IN and Analog Out, 9-Pin D for power and 37-Pin D for Digital Output

PARAMETERS	SPECIFICATIONS
Frequency Range	5.4 to 5.9 GHz
Dynamic Range	-56 dBm to +14 dBm
Maximum RF Input	+30 dBm
VSWR	2.0:1
Pulse Range	250 ns to CW
Digital Accuracy	±0.2 dB from +14 dBm to -36 dBm ±1.0 dB from -37dBm to -52 dBm ±1.6 dB from -53dBm to -56 dBm
Resolution	02. dB Max.
Bit Count Correlation	Bit count (1023) = +18 dBm Bit count (0) = 66 dBm
Data Output Rate	10 megasamples/second
Clock Signal	10 MHz, data valid for 20 ns prior to clock rising edge and 3 ns after rising edge
Analog Output Bandwidth	10 MHz Min
Analog Output Impedance	50 Ω
Analog Logging Linearity	±1.0 dB Typ
Analog Log Slope	25 mV/dB Typ
Flatness	±1.0 dB Typ

CW Immune, EW Detector Module, EWDM-2G6G-65-70MV-1

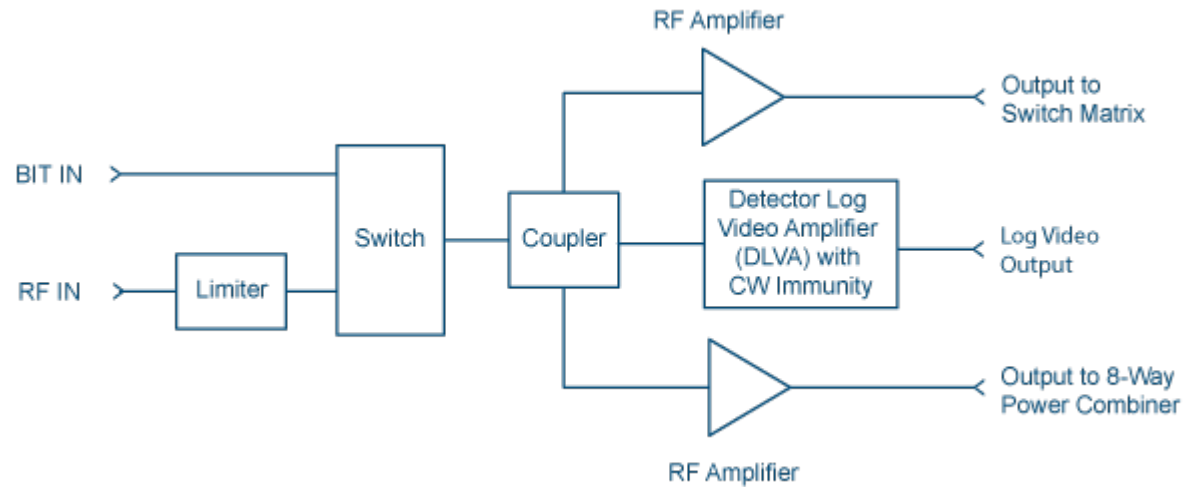

- > 2 to 6 GHz frequency operation
- > Features an internal switch used to switch between the "Bit In" and RF In" with input blanking on both ports
- > Two amplified RF outputs provide a 7 dB gain channel and a 33 dB gain channel
- > Video output is designed to drive a 150 ft. cable, while maintaining high speed, and excellent accuracy
- > Physical size 4.2" x 2.8" x 0.8" & contains SMA female connectors

Switch Isolation

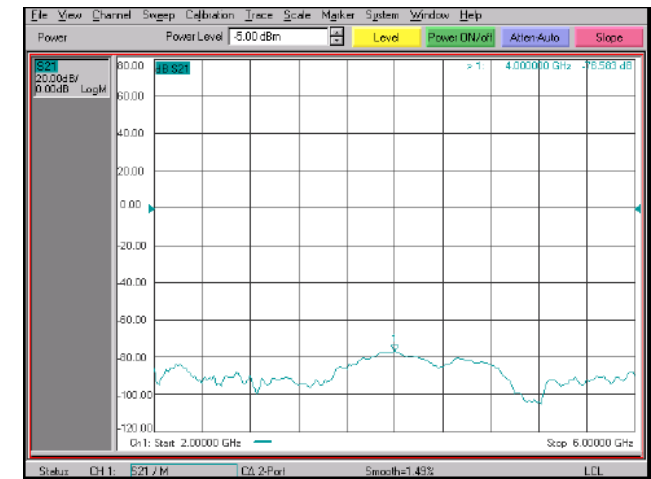
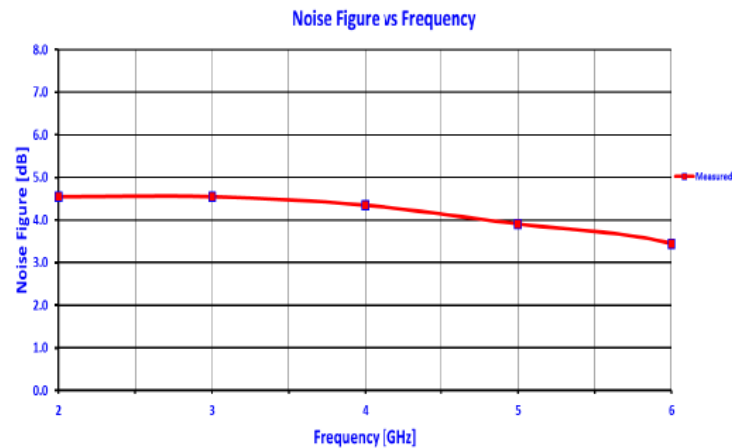

Specifications

PARAMETERS	SPECIFICATIONS
Input Frequency	2.0 to 6.0 GHz
Input VSWR	2.3:1 Max, impedance = 50 Ω
Noise Figure	8 dB Max
Input Power	1 W CW Max 100 W Peak @ 1 μs pw, 1% Duty cycle Max
SP3T Switch Specifications	
Isolation	60 dB Min among all ports
Switching Speed	100 ns Max
Output To 8-Way Power Combiner Specifications	
Linear Gain	+33 dB Min
Frequency Flatness	±2.5 dB Max
1 dB Compression Point	+3 dBm Min
Saturated Power	+14 dBm Max
Second Harmonics	-9 dBc Min
Third Harmonics	-12 dBc Min
I/O VSWR	2.3:1 Max impedance = 50 Ω
Output To Switch Matrix Specifications	
Linear Gain	+7 dB Min
Frequency Flatness	±1.5 dB Max
1 dB Compression Point	+3 dBm Min
Saturated Power	+9 dBm Max
Second Harmonic	-9 dBc Min
Third Harmonic	-12 dBc Min
I/O VSWR	2.3:1 Max impedance = 50 Ω

Log Videos Output Specifications	
TSS	-71 dBm Max
Dynamic Range	-65 to 0 dBm
Log Slope Fixed	70 mV/dB Nom
Log Linearity	±1.0 dB Max
Log Accuracy	±1.25 dB Max
Absolute Log Accuracy	±1.5 dB Max
DC Offset	0±70 mV (RF Input Terminated & DC Power On)
Rise Time (10% to 90%)	25 ns Typ, 28 ns Max
Fall Time (90% to 10%)	300 ns Max
Setting Time	50 ns within ±35 mV final value Max
Recovery Time	1 μs Max - Measured from 1 dB below peak of the first 0 dBm, 330 μs pulse where the second -60 dBm, 100 ns pulse is measured within ±1 dB error when the first 0 dBm pulse is not present
Video Frequency Flatness	±0.75 dB Max - At any constant input power from -65 dBm to 0 dBm, as frequency is varied from 6-18 GHz (25 °C)
CW Immunity	±1.5 dB Max
CW Immune Time at CW = -40 dBm	4 ms Max
CW Recovery Time at CW = -40 dBm	50 μs Max
Output Load Impedance:	75 ± 1 Ω
Output Video driver capability	Driving 150 ft RG11 into 75 Ω load
CW Immunity	±1.5 dB Max
Propagation Delay	50 ns (Excluding Cable) @ Switch is on "ON" position from 50% input RF to 10% output video, not including video cable Max

CW Immune, EW Detector Module, EWDM-6G18G-65-70MV-1

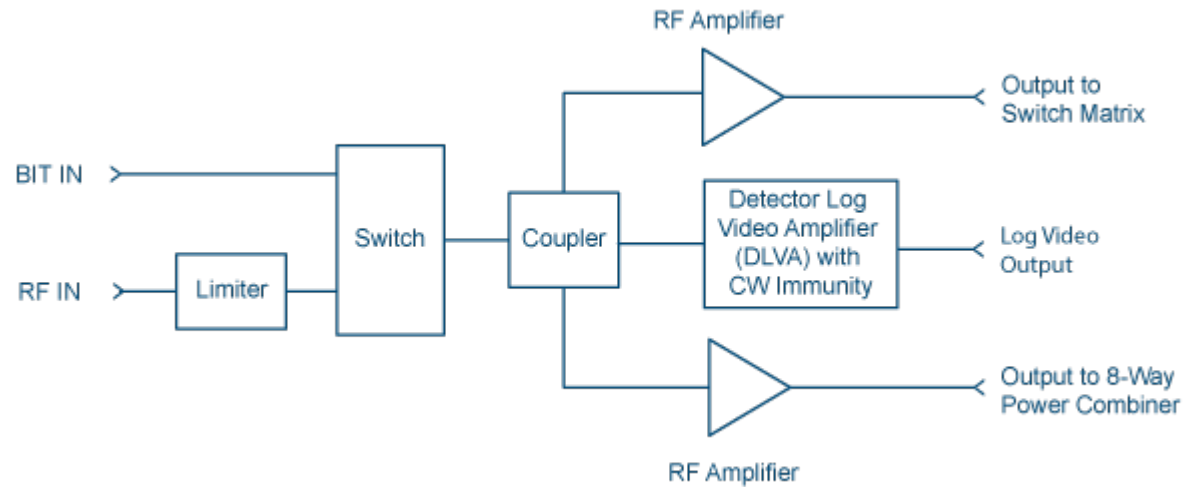

- > 6 to 18 GHz frequency operation
- > Features an internal switch used to switch between the "Bit In" and RF In" with input blanking on both ports
- > Two amplified RF outputs provide a 7 dB gain channel and a 33 dB gain channel
- > Video output is designed to drive a 150 ft. cable, while maintaining high speed, and excellent accuracy
- > Physical size 4.2" x 2.8" x 0.8" & contains SMA female connectors

Switch Isolation

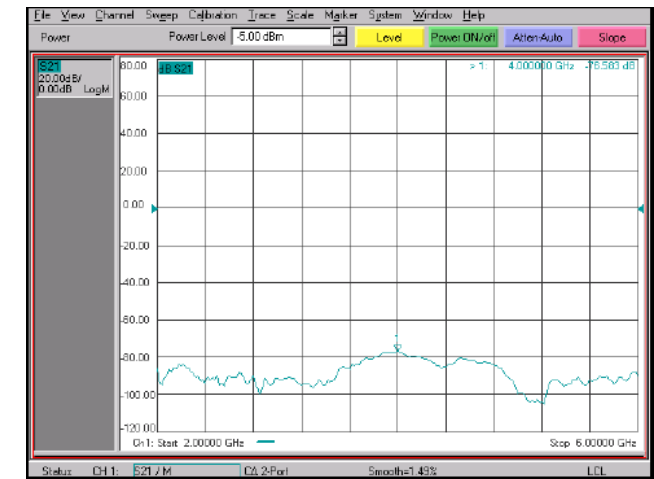
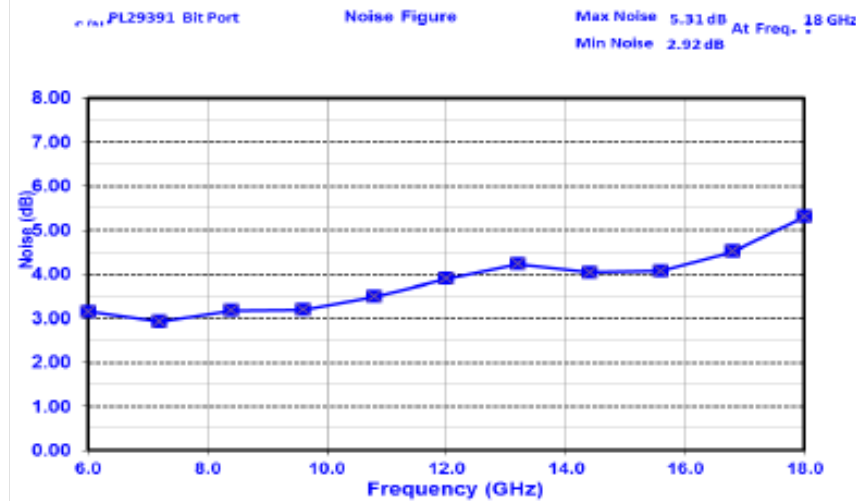

CW Immune, EW Detector Module, EWDM-6G18G-65-70MV-1

Specifications

PARAMETERS	SPECIFICATIONS
Input Frequency	6.0 to 18.0 GHz
Input VSWR	2.2:1 Max, impedance = 50 Ω
Noise Figure	6 dB Max
Input Power	1 W CW Max 100 W Peak @ 1 μs pw, 1% Duty cycle Max
SP3T Switch Specifications	
Isolation	60 dB Min among all ports
Switching Speed	100 ns Max
Output To 8-Way Power Combiner Specifications	
Linear Gain	+33 dB Min
Frequency Flatness	±2.5 dB Max
1 dB Compression Point	+3 dBm Min
Saturated Power	+14 dBm Max
Second Harmonics	-9 dBc Min
Third Harmonics	-12 dBc Min
I/O VSWR	2.2:1 Max impedance = 50 Ω
Output To Switch Matrix Specifications	
Linear Gain	+7 dB Min
Frequency Flatness	±1.5 dB Max
1 dB Compression Point	+3 dBm Min
Saturated Power	+9 dBm Max
Second Harmonic	-9 dBc Min
Third Harmonic	-12 dBc Min
I/O VSWR	2.2:1 Max impedance = 50 Ω

Log Videos Output Specificationsz	
TSS	-71 dBm Max
Dynamic Range	-65 to 0 dBm
Log Slope Fixed	70 mV/dB Nom
Log Linearity	±1.0 dB Max
Log Accuracy	±2.0 dB Max
Absolute Log Accuracy	±2.25 dB Max
DC Offset	0±70 mV (RF Input Terminated & DC Power On)
Rise Time (10% to 90%)	25 ns Typ, 28 ns Max
Fall Time (90% to 10%)	300 ns Max
Setting Time	50 ns within ±35 mV final value Max
Recovery Time	1 μs Max - Measured from 1 dB below peak of the first 0 dBm, 330 μs pulse where the second -60 dBm, 100 ns pulse is measured within ±1 dB error when the first 0 dBm pulse is not present
Video Frequency Flatness	±1.75 dB Max - At any constant input power from -65 dBm to 0 dBm, as frequency is varied from 6-18 GHz (25 °C)
CW Immunity	±1.5 dB Max
CW Immune Time at CW = -40 dBm	3 ms Max
CW Recovery Time at CW = -40 dBm	50 μs Max
Output Load Impedance:	75 ± 1 Ω
Output Video driver capability	Driving 150 ft RG11 into 75 Ω load
CW Immunity	±1.5 dB Max
Propagation Delay	50 ns (Excluding Cable) @ Switch is on "ON" position from 50% input RF to 10% output video, not including video cable Max

CW Immune ERDLVA, ERDLVA-218-CW-75MV



- > Operates from 2.0 to 18.0 GHz
- > TSS of -42 dBm, a log slope of 75 ± 10 mV per dB, and a rise/recovery time of 25 ns/500 ns
- > Unit size is 2.90" x 2.30" x 0.50" with SMA female connectors

PARAMETERS	SPECIFICATIONS
Frequency Range	2 to 18 GHz
TSS	-42 dBm
Log Slope	75 ± 10 mV Max per dB
Log Range	-40 dBm to +20 dBm
Log Slope Linearity:	-40 to +20 dBm ± 1.00 dB Max @ 25°C, ± 1.5 dB Max over Temperature
Frequency Flatness	± 1.5 dB Max at -20 dBm
Impedance	50 ohms ± 2 %
VSWR	Less than 2.5:1 Max up to -20 dBm input <3.0:1 Max up to +15 dBm input
Input Pulse Width	Within 10 ns of RF pulse width @ -5 dB from peak and 50 ns to 250 us of pulse width range
Video Log Range	300 mV to 4800 mV Nom
Video Bandwidth	20 MHz Min over 60 dB logging range
Duty Cycle	0 - 70 %
Video Output Level	300 ± 50 mV @25°C
Dynamic Range	± 75 mV -40 dBm to +20 dBm
Input Power Handling	CW RF input levels of +23 dBm Min

CW Immune ERDLVA, ERDLVA-2G18G-65-70MV-70C



- > Operates from 2.0 to 18.0 GHz. The
- > Video output is designed to drive a 100 ft cable into a 75 Ω load over the temperature range of -40 °C to +70 °C.
- > Unit size is 3.5" x 2.5" x 0.5" with SMA female connectors

PARAMETERS	SPECIFICATIONS
Frequency Range	2 to 18 GHz
TSS	-71 dBm
Log Slope	70 ± 3 mV/dB
Log Range	-65 to 0 dBm
Video Freq Flatness	+/- 2.0 dB Max @ 25 °C
Video Load Impedance	75 Ω
Propagation Delay	50 ns Max from 50% RF to 10% Video
Dynamic Range	-65 to 0 dBm
Pulse Width Process Range	100 ns to 300 μs
Pulse Density Capability	10% duty @ 100 ns PW, 70% Duty @ 300 μs PW at peak power -10 dBm with acceptable 1 dB pulse amplitude and baseline variable
Noise Level	160 mV P-P Max
Input Power	1 W CW, 100 W Peak @ PW = 1 μs & 1% Duty (Max)
Input VSWR	2.2:1 Max
CW Immune Time at CW = -40 dBm	4 ms Max
CW Recovery Time at CW = -40 dBm	20 μs Max

Successive Detection Log Video Amplifiers (SDLVAs)

Standard Connectorized Models....



0.5 to 18 GHz SDLVA



55 to 60 MHz
Limited IF Output SDLVA



100 to 700 MHz
SDLVA



100 MHz to 18 GHz
CW-Immune SDLVA



0.1 to 2 GHz
Limited IF SDLVA



0.12 to 0.2 GHz SDLVA



315 to 362 MHz
Log IF Amplifier



315 to 362 MHz
SDLVA



0.5 to 18 GHz SDLVA



0.7 to 1.3 GHz SDLVA



0.75 to 1.25 GHz
GPO SDLVA

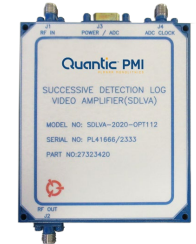

1 to 12 GHz, SDLVA



2 to 6 GHz, SDLVA



2 to 18 GHz,
CW Immune SDLVA



4 to 18 GHz, SDLVA



6 to 18 GHz, SDLVA



8 to 18 GHz, SDLVA



18 to 40 GHz, SDLVA

SDLVA, SDLVA-50M18G-70



- > Operating in the 50 MHz to 18 GHz frequency band
- > Features a built-in voltage variable threshold detector circuit that is set up to match the video output voltage to within 5%
- > TSS of -70 dBm and a dynamic range of 70 dB,
- > Gold plated finish, package measures 2.3" x 2.2" x 0.4", SMA Female connectors

PARAMETERS	SPECIFICATIONS
Frequency Range	0.05 to 18.0 GHz
Frequency Flatness	±2.0 dB Max.
TSS	-70 dBm Typ
VSWR	2.0:1 Max
Video Comparator Output (V0)	5 V Into 1 MΩ, 2.5 V Into 50 Ω (Typ)
Video Comparator Threshold Level	Adjustable: -60 dBm to 0 dBm (Operating Range) Threshold Level = V1 ±5% and ±25 mV (Hysteresis)
Log Range	-70 dBm to 0 dBm Min
Log Slope	25 mV.dB (±5%) @ 50 Ω Load
Log Linearity	±1.75 dB (-65 to 0 dBm) Max
Pulse Range	100 ns to DC
Rise Time	400 ns Max
Power Supply	+12 to +15 VDC @ 400 mA -12 to -15 VDC @ 200 mA

Limited IF Output SDLVA, SDLVA-0060-80



- > Operates over the 55 to 65 MHz Frequency Range.
- > Offers dynamic range of 80 dB typical, with a nominal video bandwidth of 20 MHz
- > Designed using Planar Monolithic technology which provides stunning performance and reliability in a compact package, making it an optimum high-speed channelized receiver applications
- > Offers typical fast rise time ≤ 20 ns, rapid fall time ≤ 30 ns as well as superior delay time of 10 ns.
- > Physical size is 3.75" x 1.50" x 0.50" with SMA female connectors

PARAMETERS	SPECIFICATIONS
Frequency Range	0.055 to 0.065 GHz
Output Voltage	2.7 V
Log Slope	25 mV/dB Nom
Log Range	-80 to 0 dBm Typ
Rise Time	20 ns Max
Fall Time	30 ns Max
Power Supply	+15 Volts @ 100 mA, -15 Volts @ 190 mA
VSWR	1.5:1 Max
Video Load Impedance	1000 Typical
Propagation Delay	10 ns Typical
Pulse Range	<100 ns
Dynamic Range	80 dB Min
Input Power	+10 dBm Max
Limited IF Output	0 dBm Typical
Log Video Output Coupling	DC
Log Slope Variation with Temperature	± 1 mV Nominal

Limited IF Output SDLVA, SDLVA-0060-80

Performance

SDLVA-0120-70
LOG TRANSFER WITH FREQUENCY @ +25 DEG C

TESTED BY: R. AFABLE
DATE: JULY 26, 2004

SERIAL #: PM407505



PLANAR
MONOLITHIC
INDUSTRIES

-80	-75	-70	-65	-60	-55	-50	-45	-40	-35	-30	-25	-20	-15	-10	-5	0	RF input power (dbm)
-----	-----	-----	-----	-----	-----	-----	-----	-----	-----	-----	-----	-----	-----	-----	----	---	----------------------

FREQUENCY	55 MHz	118	247	378	506	620	738	844	959	1073	1187	1299	1412	1523	1640	1744	1861	1973	Measured Values (mv)
SLOPE	22.9 mv/db	-31	-16	0	13	13	16	7	8	7	6	4	2	-2	1	-10	-8	-10	Error (mv)
INTERCEPT	1983 mv																		

FREQUENCY	60 MHz	127	261	386	509	622	739	845	959	1073	1187	1300	1416	1533	1654	1760	1880	1989	Measured Values (mv)
SLOPE	23.0 mv/db	-24	-5	4	12	10	12	3	1	0	-1	-3	-3	-1	5	-4	0	-6	Error (mv)
INTERCEPT	1995 mv																		

FREQUENCY	65 MHz	123	246	366	484	599	716	821	935	1049	1162	1275	1392	1506	1630	1739	1861	1969	Measured Values (mv)
SLOPE	23.0 mv/db	-10	-2	3	7	7	9	-1	-2	-2	-4	-6	-4	-4	5	-1	6	-1	Error (mv)
INTERCEPT	1970 mv																		

IF OUTPUT	55 MHz	-0.74	-0.25	-0.17	-0.15	-0.15	-0.15	-0.15	-0.15	-0.14	-0.14	-0.14	-0.14	-0.14	-0.13	-0.13	-0.11		
-----------	--------	-------	-------	-------	-------	-------	-------	-------	-------	-------	-------	-------	-------	-------	-------	-------	-------	--	--

IF OUTPUT	60 MHz	-0.53	-0.24	-0.18	-0.16	-0.16	-0.15	-0.15	-0.15	-0.15	-0.16	-0.15	-0.16	-0.16	-0.15	-0.14	-0.13		
-----------	--------	-------	-------	-------	-------	-------	-------	-------	-------	-------	-------	-------	-------	-------	-------	-------	-------	--	--

IF OUTPUT	65 MHz	-0.55	-0.28	-0.21	-0.19	-0.18	-0.18	-0.18	-0.18	-0.18	-0.18	-0.18	-0.19	-0.19	-0.19	-0.18	-0.16		
-----------	--------	-------	-------	-------	-------	-------	-------	-------	-------	-------	-------	-------	-------	-------	-------	-------	-------	--	--

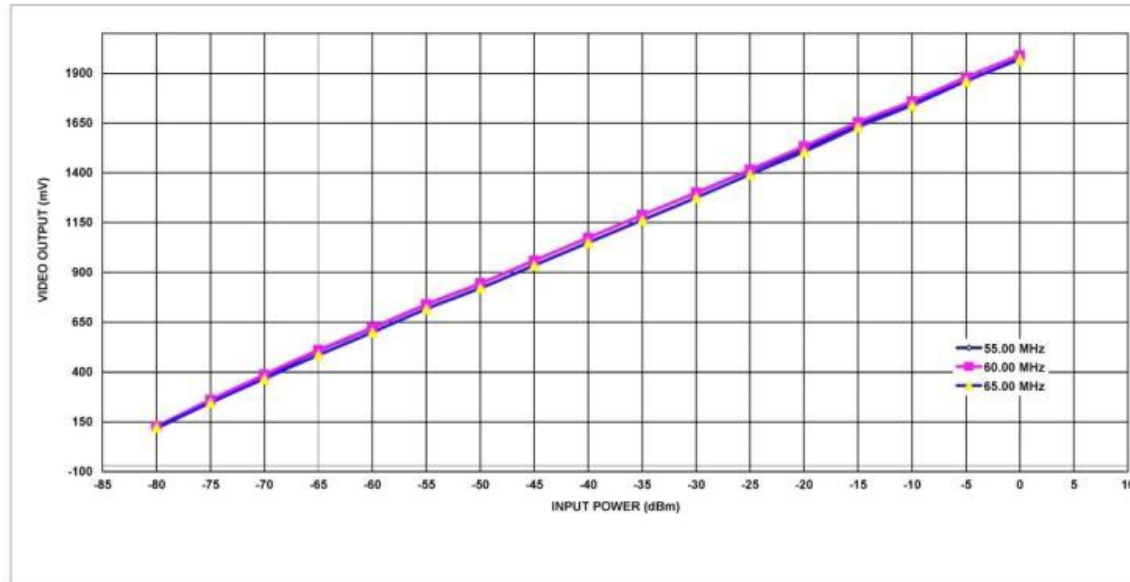

SDLVA, SDLVA-100M700M-70

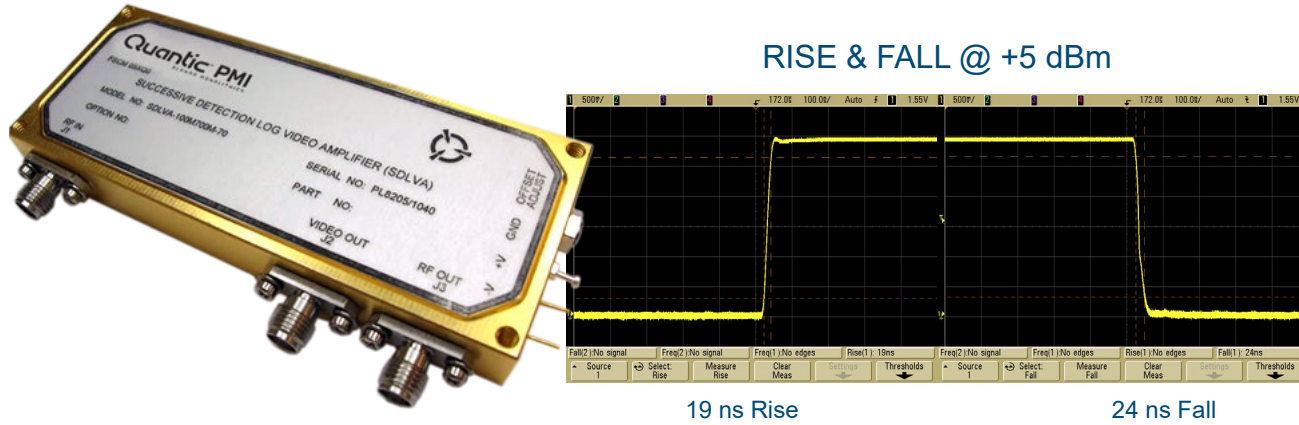

- Operates over the 100 to 700 MHz Frequency Range
- Offers a Dynamic Range of 55 dB, a TSS of -60 dBm typical AND a Nominal Video Bandwidth of 20 MHz
- Designed using innovative GaAs Technology which provides stunning performance and reliability in a compact package making it an optimum solution for high-speed channelized receiver applications

PARAMETERS	SPECIFICATIONS
Frequency Range	100 to 700 MHz
Dynamic Range	55 dB Min, 60 dB Typ
Log Linearity	±1.2 dB Typ, ±1.2 dB Max@ (-55 to 0 dBm) ±1.5 dB Typ, ±2.0 dB Max@ (-60 to 0 dBm)
Minimum Log Voltage	-55 dBm (-60 dBm Typ)
Max Log Voltage	0 dBm (+10 dBm Typ)
VSWR Input	2.0:1 Max (1.5:1 Typ)
Tangential Sensitivity	-60 dBm Typ (Video In)
Limited IF Output	-10 dBm Min, -5 dBm Typ
Max RF Input Power	+10 dBm
Log Video Output Coupling	DC
Log Video Max Output Voltage	2.7 Volts
Log Video Output Rise Time	15 ns Typ, 25 ns Max
Log Video Output Fall Time	15 ns Typ, 30 ns Max
Log Video Output Settling Time	40 ns Max
Log Video Output DC Offset	0.1 Volts Nominal (Adjustable)
Log Video Output Slope	25 mV/dB Nominal ±5 mV/dB
Log Video Output Variation with Frequency	±0.5 mV/dB Typ (Over 80 MHz RF Bandwidth)
Log Video Output Variation with Temperature	±1 mV/dB Typ
Log Video Propagation Delay	10 ns Max, 7 ns Typ
Log Video Load	100 ohms ±10%

CW Immune SDLVA, SDLVA-100M18G-CW-70-MAH

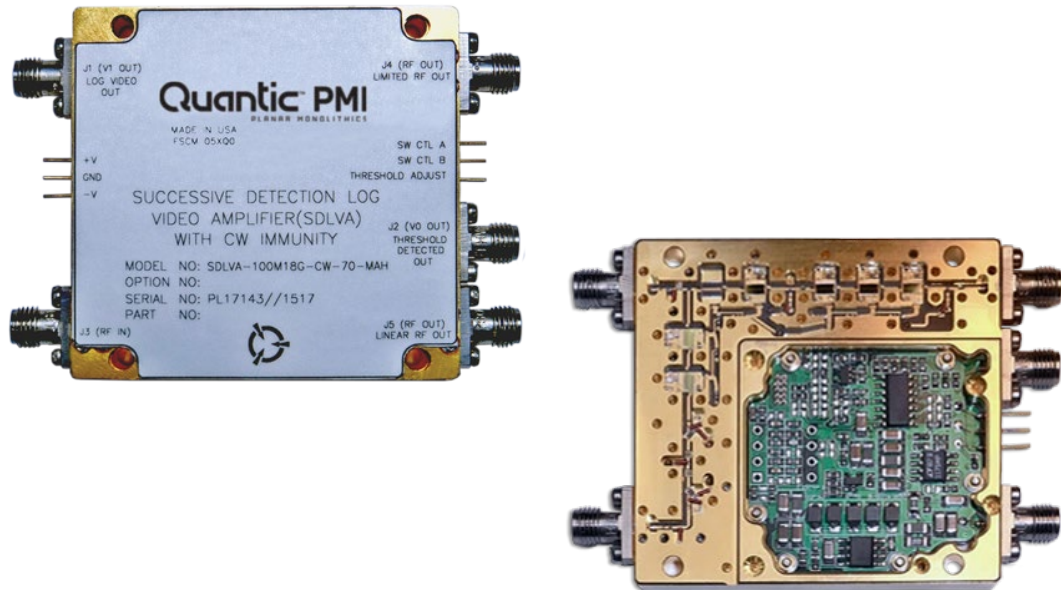

- > Operating frequency range of 100 MHz to 18 GHz
- > Features a SPST on the RF output for the RF blanking, a 3.3 V TTL-compatible output for time-gating or sampling, to assist in digital system integration
- > Contains SMA female connector and has a package size of 2.0" x 2.2" x 0.36"

PARAMETERS	SPECIFICATIONS
Frequency Range	100 MHz to 18.0 GHz
Frequency Flatness	±2.0 dB Max
TSS	-68 dBm Min, -70 dBm Typ
Limited Output Power	8.0 dBm ±3.0 dB Max(Input Power >= -65 dBm)
VSWR	2.0:1 Max
Linear Output Gain	43 dB ±3.0 dB Max
Linear Output Psqt	3 dBm ±3.0 dB Max
V0 (Video Comparator Signal Amplitude)	3.3 V Typ
Video Comparator Delay	50 ns Typ
Video Comparator Threshold Level	Adjustable with Analog Voltage -60 dBm ±3.0 dB Max
V1 (Log Video Signal Amplitude)	1 Volt Max
Log Slope	10 mV/dB into a 50 ohm Load ±1 mV Max
Log Range	-65 to +5 dBm Min
Log Linearity	±1.75 dB (-40 °C to +85 °C) Max
Pulse Range	100 ns to 250 µs
Rise Time	35 ns Max
Settling Time to ±1dB	50 ns Typ
Recovery Time	350 ns Max
CW Immunity Range	TSS to -45 dBm (1 dB degradation)
Pulse Considered "CW"	1 ms Typ
Rejection Time	1 ms Typ
Droop	1 dB Max
SPST Isolation	70 dB Typ
SPST Switch Speed	20 ns Typ

Performance

Typ VIDEO OUTPUT vs INPUT POWER
ALL TEMPERATURE LEVELS

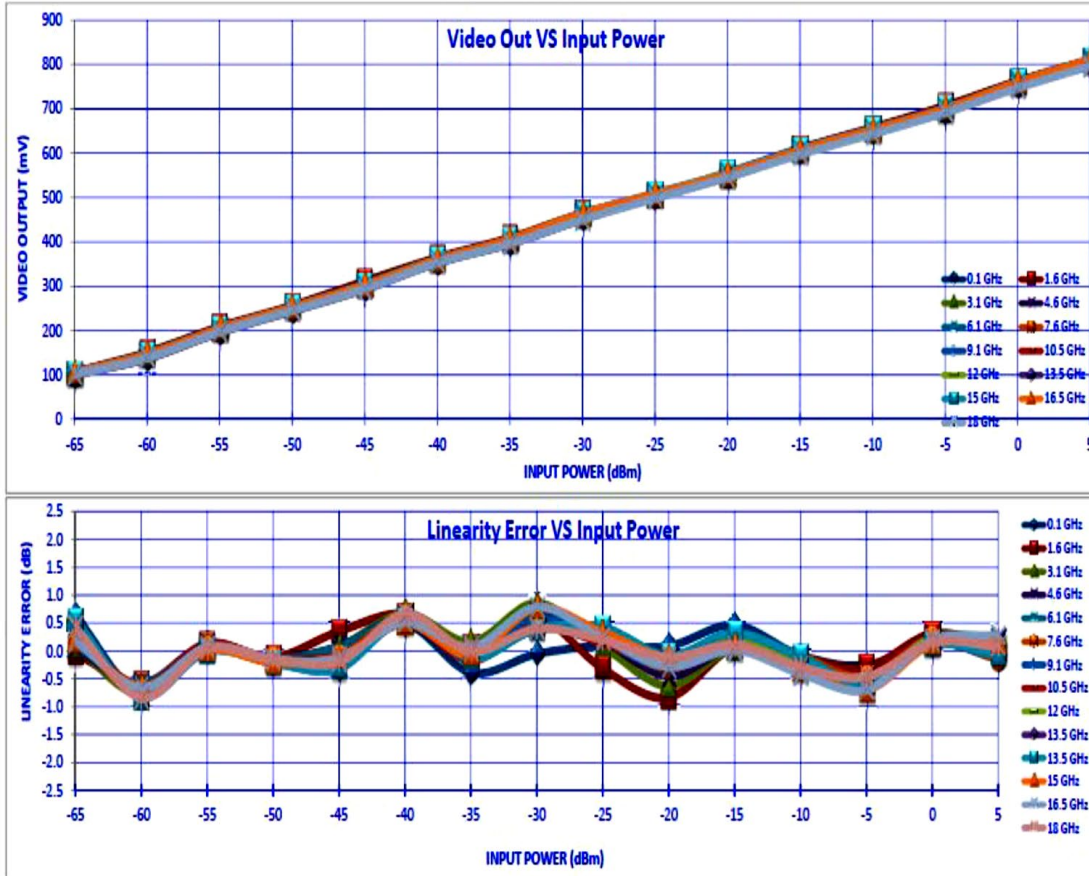

Recovery Time, Comparator Delay and Switching Speed

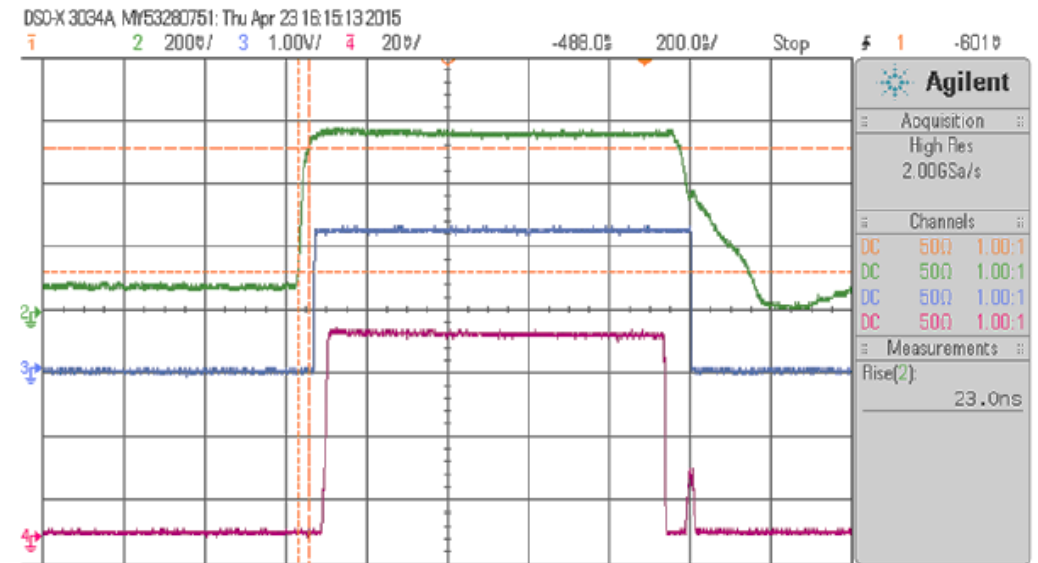

Green Trace(2):
Blue Trace(3):
Magenta Trace(4):

Video Signal (V1)
Video Comparator Signal (V0)
RF Output Switching Speed Measured with a Tunnel Diode

Limited IF SDLVA, SDLVA-0120-70-100M2G-10DBM



- > Operates between the 0.1 to 2.0 GHz
- > Dynamic range of 70 dB minimum & a TSS of -65 dBm
- > Provides a limited IF output of +10 dBm
- > Physical size is 3.75" x 1.5" x 0.4" & has SMA connectors

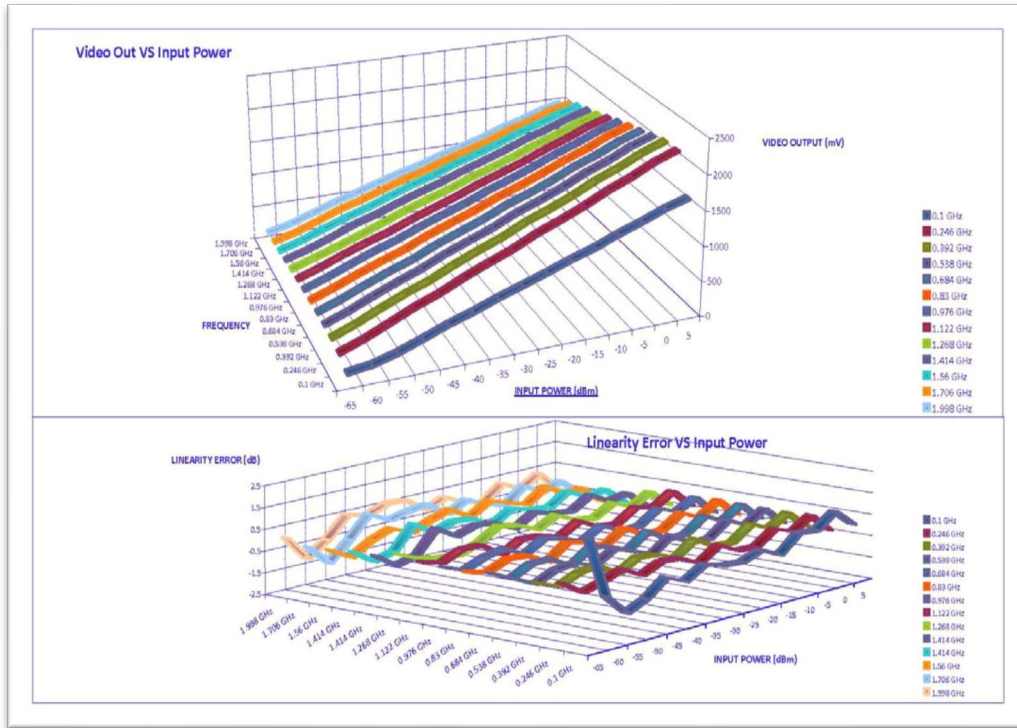

PARAMETERS	SPECIFICATIONS
Frequency Range	0.1 to 2.0 GHz
Dynamic Range	70 dB Min, 75 dB Typ
Log Linearity	±2.0 dB Max (-65 to +5 dBm)
Log Linearity @ 100MHz	±2.0 dB Max. (-50 to +5 dBm)
Minimum Log Range	-65 dBm
Max Log Range	+5 dBm
VSWR Input	2.0:1 MAX., (1.8:1 TYP).
Tangential Sensitivity	-65 dBm Min (-70dBm TYP)
Limited IF Output	+10 dBm
Max RF Input Power	+10 dBm
Log Video Output Coupling	DC
Log Video Max Output Voltage	2.7 v
Log Video Output Rise Time	25 ns Max
Log Video Output Fall Time	30 ns Max
Log Video Output Settling Time	40 ns Max
Log Video Output DC Offset	0.1 v Nominal (Adjustable)
Log Video Output Slope	25 mV/dB Nominal (At 1 GHz)
Log Video Output Variation with Frequency	±0.5 mV/dB (Over 80 MHz RF Bandwidth)
Log Video Output Variation with Temperature	±0.5 mV/dB Typ
Log Video Propagation Delay	10 ns Typ
Log Video Load	100 ohms ±10%

SDLVA, SDLVA-160-80



- > Operates between the 120 to 200 MHz frequency range
- > Offers a dynamic range of 80 dB, a log slope of 25 mV / dB, and a nominal video bandwidth of 12 MHz
- > Designed using cutting edge GaAs technology which provides stunning performance and reliability in a compact package making it an optimum solution for high-speed channelized receiver applications
- > Supplied in a compact housing measuring 3.53" x 1.50" x 0.46" with SMA Connectors

PARAMETERS	SPECIFICATIONS
Frequency Range	0.12 to 0.2 GHz
Size:	3.53" x 1.50" x 0.46"
Log Slope	25 mV/dB \pm 3%
Log Linearity	\pm 1.0 dB
Dynamic Range	-80 to 0 dBm
Limited IF Output	+0 dBm \pm 2.0 dB
Log Video Output Coupling	DC
VSWR Input/Output	2.0:1 Max
Log Video Output DC Offset	\pm 20 mV
Log Video Output Fall Time	60 ns
Log Video Output Rise Time	30 ns
Log Video Output Slope	25 mV/dB \pm 3%

Log IF Amplifier, SDLVA-315362-1



- > Operates over the 315 MHz to 362 MHz frequency range
- > Designed for high-speed applications while maintaining flatness and accuracy
- > Physical size is 4.28" x 1.5" x 0.468" & has SMA connectors

PARAMETERS	SPECIFICATIONS
Frequency Range	315 to 362 MHz
Frequency Flatness	±2.0 dB Max
TSS	-73 dBm Min
VSWR	1.5:1
Power Input	+17 dBm CW Max
Log Slope	50 mV/dB (±1.5 mV/dB) 100 Ω Load
Log Range	-65 to 0 dBm (0.25 V @ -65 dBm to 3.5 V @ 0 dBm)
Log Accuracy	±0.75 dB (+50 °C) Max ±1.5 dB (0°C to +77 °C) Max ±2.5 dB (-33 °C to 0 °C) Max
Pulse Range	100 ns to CW
Rise Time	35 ns Max.
Fall Time	300 ns Max.
Recovery Time	500 ns Max.
Power Supply	±12 V ±3%
Quiescent Power Dissipation	2 Watts Max

SDLVA, SDLVA-315M362M-65-CD-1



- Dynamic range of 65 dB over the 315 to 362 MHz frequency range
- Offers a fast rise time of 35 ns maximum and a recovery time of less than 500 ns
- Temperature compensated such that log accuracy over temperature remains less than +/-2.5 dB over the full operating temperature range of -33 to +77 °C
- Gold-plated compact housing measuring 3.75" x 1.5" x 0.5" with SMA (F) connectors

PARAMETERS	SPECIFICATIONS
Frequency Range	315 to 362 MHz
Frequency Flatness	±2.0 dB Max
TSS	-73 dBm Min (Video In)
VSWR	1.5:1 Max
Power Input	+17 dBm Max
Log Slope	50 mV/dB (±1.5 mV/dB) 100 Ohm Load
Log Range	-65 to 0 dBm (0.25 V @ -65 dBm 3.5 V @ 0 dBm)
Log Accuracy	±0.75 dB (+50 °C) Max ±1.5 dB (0°C to +77 °C) Max ±2.5 dB (-33 °C to 0 °C) Max
Pulse Range	100 ns to CW
Rise Time	35 ns
Fall Time	300 ns
Recovery Time	500 ns
Offset Adjust	±0.4 V Typ
Power Supply	±12 V ±3%
Quiescent Power Dissipation	2 Watts Max

SDLVA, SDLVA-500M4G-CD-1



- 70 dB Dynamic Range over the 0.5 to 4.0 GHz frequency range
- Offers an ultra-fast rise time of 10 ns maximum, a recovery time of less than 60 ns
- limited RF Output of +7 dBm
- Temperature compensated such that log linearity over temperature remains less than +/-2.5 dB over the full operating temperature range of -40 to +70 °C
- Supplied in a compact housing measuring 3.2" x 1.8" x 0.4" with SMA Connectors
- Optional frequency ranges covering 100 MHz to 26.5 GHz are available

PARAMETERS	SPECIFICATIONS
Frequency Range	0.5 to 4.0 GHz
RF Gain (Small Signal)	55 dB Typ.
Video Flatness Over Frequency	±50 mV Max
TSS	-73 dB Typ., -71 dB Max
VSWR	2.0:1
PSAT	+7 dBm Typ
Power Input	+17 dBm CW Max.
Log Slope	35 mV/dB Typ (50 Ω Load)
Log Range	-70 to 0 dBm
Log Linearity	±2.5 dB (-40 to +75 °C)
DC Offset	50 ±50 mV
Pulse Range	30 ns to CW
Rise Time	10 ns (5 ns Typ)
Recovery Time	60 ns (40 ns Typ)

SDLVA, SDLVA-0R5G18G-50R-30DBM



- > Operates over the 0.5 to 18.0 GHz frequency range
- > Designed for ultra high-speed applications while maintaining flatness and accuracy
- > Physical size is 3.2" x 1.8" x 0.4" with gold-plated finish and has SMA connectors

PARAMETERS	SPECIFICATIONS
Frequency Range:	0.5 to 18 GHz
TSS:	-71 dBm Min
Log Slope:	25 mV/dB ($\pm 10\%$) @ 50 OHM Load
Log Range:	-70 dBm to 0 dBm
Rise Time:	20 ns Max - Measured 6.6 ns
VSWR:	2.5:1 Max
Pulse Range:	50 ns to CW
Dynamic Range:	-70 to 0 dBm
Video Output Range:	0 to 2.2 VDC into a 50 Ohm Load
Input Power:	+30 dBm CW Max
Log Slope Intercept Point:	-70 dBm RF Input Video Out = 350 mV (Nom) @ +25 °C - Measured 325 mV
Max Video Output:	2.4 VDC

SDLVA, SDLVA-0R71R3-75-CD-1



- > Operates over the 700 to 1300 MHz frequency range
- > Offers a Dynamic Range of 75 dB, a log slope of 40 mV/dB and a nominal video bandwidth of 20MHz
- > Designed using cutting edge GaAs technology which provides stunning performance and reliability in a compact package making it an optimum solution for high-speed channelized receiver applications
- > Supplied in a compact housing measuring 3.75" x 1.50" x 0.50" with SMA Connectors

PARAMETERS	SPECIFICATIONS
Frequency Range	0.7 to 1.3 GHz
Dynamic Range	>75 dB
Log Linearity	±0.8 dB Typ, ±1.2 dB Max @ -60 to 0 dBm ±1.2 dB Typ, ±1.5 dB Max @ -65 to +5 dBm
Minimum Logging Range	-70 dBm
Maximum Logging Range	+5 dBm Typ
VSWR Input	1.5:1 Typ., 1.8:1 Max
Tangential Sensitivity	-70 dBm Typ.
Limited IF Output	+5 dBm Typ.
Maximum RF Input Power	+10 dBm CW
Log Video Output Coupling	DC
Rise Time	15 ns Typ., 25 ns Max
Fall Time	15 ns Typ., 30 ns Max
Settling Time	40 ns Max.
Log Slope Variation with Frequency	±0.5 mV/dB Typ. (Over 80 MHz RF Bandwidth)
Log Slope Variation with Temperature	±1 mV/dB Typ
Propagation Delay	10 ns Max., 7 ns Typ
Video Load	50 Ω ±10%

SDLVA, SDLVA-07103-70-LA3

GPO (Full Detent)



- > Operates over the 750 MHz to 1.25 GHz frequency range
- > Offers 70 dB high dynamic range (minimum); a normal 20 MHz video bandwidth; Log linearity is ± 1.5 dB from the best fit straight line over the dynamic range of -65 to +5 dBm.
- > Compact size is 1.30" x 0.95" x 0.27" with GPO (Full Detent) connectors

PARAMETERS	SPECIFICATIONS
Frequency Range:	750 MHz to 1.25 GHz
TSS:	-70 dBm Max
Log Slope:	30 mV/dB $\pm 5\%$
Log Range:	-65 dBm Max - Measured <-65 dBm +5 dBm Min - Measured +5 dBm
Log Linearity:	± 1.5 dB Max (-65 to +5 dBm) - Measured +1.0/-1.49 dB (-65 to +5 dBm)
Rise Time:	25 ns Max (20 ns Typ)
Fall Time:	30 ns Max - Measured 13.3 ns
Recovery Time:	50 ns Max (90% Input Pulse to Within 0.5 dB)
Settling Time:	40 ns Max (10% Input Pulse to Within 0.5 dB)
VSWR:	2.0:1 Max
Dynamic Range:	70 dB Min
Limited IF Output:	8.5 dBm Min (-65 to -60 dBm) 9.5 to 12.5 dBm (-60 to +5 dBm)
Log Video Output Coupling:	DC

SDLVA with Digital Log Video Output, SDLVA-2020-OPT112

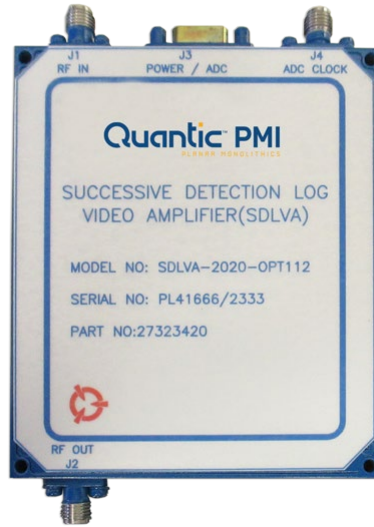

- > DC-coupled successive detection log video amplifier (SLDVA) that has 40 dB dynamic range over the frequency range of 1.0 to 12.0 GHz
- > Provides an 8-Bit Digital Log Video Output
- > Employs planar diode detectors and integrated video circuitry for high-speed performance and outstanding reliability
- > Superior construction using state of the art MIC technology
- > Physical size is 3.0" x 3.5" x 0.5" with SMA connectors

PARAMETERS	SPECIFICATIONS
Frequency Range	1.0 to 12.0 GHz
Frequency Flatness	±2.0 dB Typ, ±2.5 dB Max
TSS	-65 dBm Max
VSWR	3.0:1 Max (@ -20 dBm)
Logging Range	-65 to -35 dBm
Log Linearity	±1.75 dB Max (-65dBm to -35 dBm)
Log Slope	5 LSB/dB Nominal
Log Temperature Stability	±1.75 dB (0°C to 60 °C)
Rise Time (10% to 90%)	20 ns Max
Recovery Time	200 ns Max
Output Power	+10 dBm ±2.5 dB Typ
ADC Clock Rate(J4)	100 MHz
Digital Log Video Output	8-Bit LVTTTL

Performance

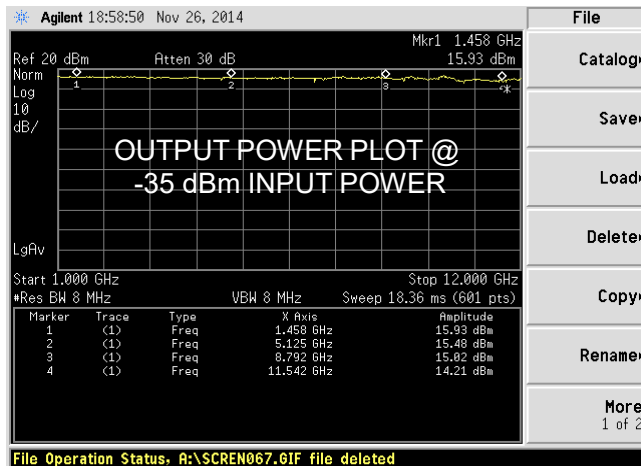
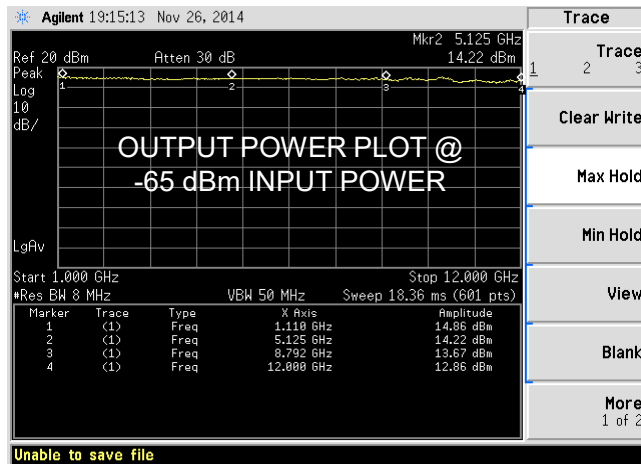

VIDEO OUTPUT vs INPUT POWER

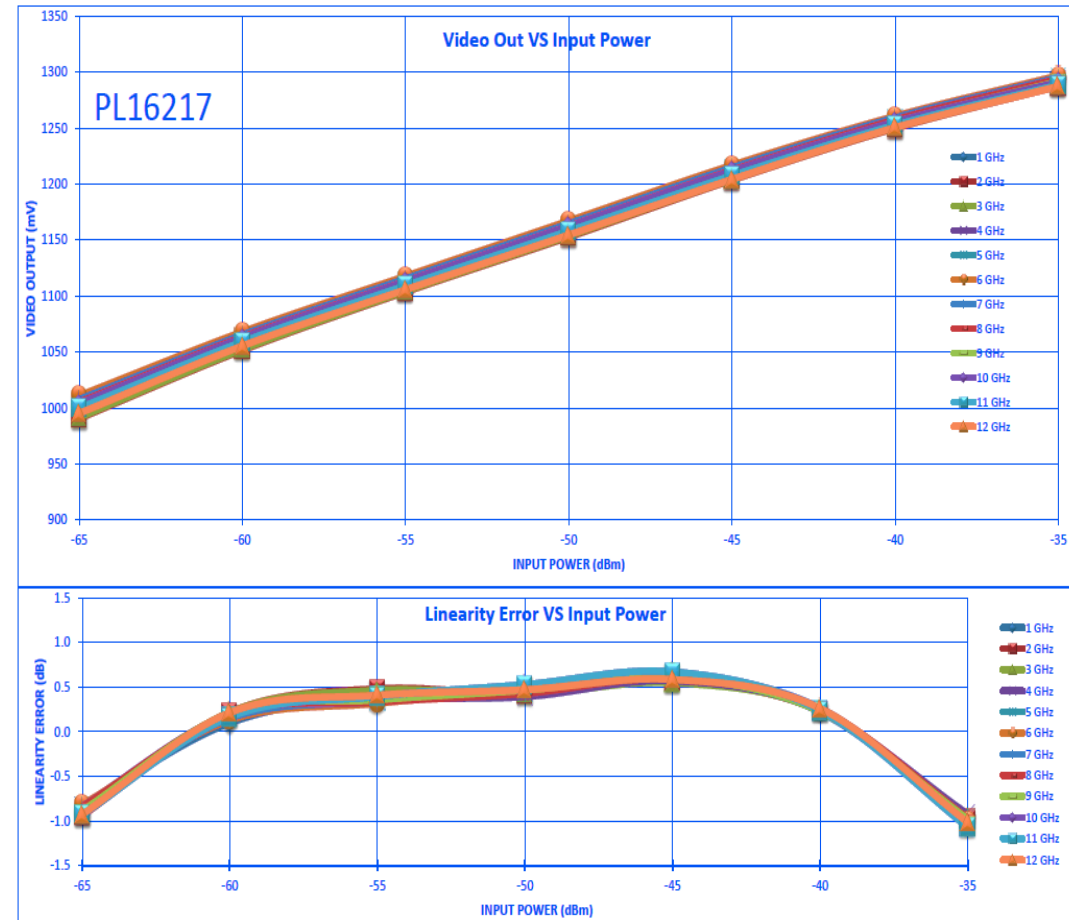

SDLVA, SDLVA-2G6G-70-CD-1



- > 2.0 to 6.0 GHz frequency range coverage
- > Dynamic range of 70 dB, a log slope of 40mV/dB and offers very fast rise and fall times of 15 ns and 25 ns respectively
- > Temperature compensated such that the Log Slope Variation with Temperature is typically ± 0.6 mV/dB and the Frequency Flatness is better than ± 1.2 dB
- > Designed using cutting edge GaAs technology which provides stunning performance and reliability making it an optimum solution for high speed, channelized receiver applications
- > Compact package measuring 3.75" x 1.5" x 0.5" with SMA connectors

PARAMETERS	SPECIFICATIONS
Frequency Range	2.0 to 6.0 GHz
Dynamic Range	-65 dBm to 5 dBm
Log Linearity	± 1.75 dB Max.
Log Accuracy	+1.75 dB Max.
Frequency Flatness	± 1.75 dB Max.
Max Video Output	3.5 V
Max RF Output	+5 dBm
RF Gain	70 dB Typ.
Max Logging Range	+5 dBm
Min Logging Range	-70 dBm
Log Video Output	
Output Coupling	DC
Rise Time	15 ns Typ, 25 ns Max.
Fall Time	25 ns Typ, 30 ns Max.
DC Offset	0.15 V Nominal (Adjustable)
Log Slope	40 mV/dB Nominal
Log Slope Variation w/ Frequency	± 1.5 mV/dB Typ.
Log Slope Variation w/Temp	± 1.2 mV/dB Typ.

CW Immune, SDLVA, SDLVA-3G18G-CW-70-MAH

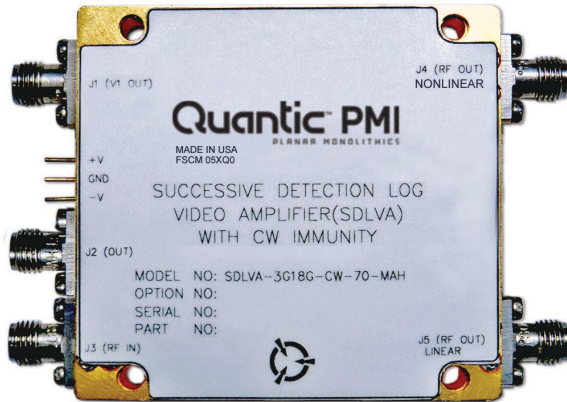

- > Operates over the 2.0 to 18.0 GHz frequency band
- > Features an SPST on the RF output which allows for the RF to be blanked when the RF input signal is below the -64 dBm threshold
- > A 3.3 V TTL-compatible output provides for time-gating or sampling to assist in digital system integration

PARAMETERS	SPECIFICATIONS
Frequency Range	2.0 to 18.0 GHz
Frequency Flatness	±2.0 dB Max
TSS	-68 dBm Min, -70 dBm Typ
Limited Output Power	6.5 dBm ±3.0 dB Max
VSWR	2.0:1 Max
Linear Output Gain	43 dB ±3.0 dB Max
Linear Output Psat	3 dBm ±3.0 dB Max
V0 (Video Comparator Signal Amplitude)	3.3 V Typ
Video Comparator Delay	50 ns Typ
Video Comparator Threshold Level	-64 dBm ±3.0 dB Max
V1 (Log Video Signal Amplitude)	1 Volt Max
Log Slope	10 mV/dB into a 50 Ω Load (±1 mV) Max
Log Range	-65 to +5 dBm Min
Log Linearity	±1.75 dB (-40 °C to +85 °C) Max
Pulse Range	100 ns to 250 μs
Rise Time	35 ns Max
Settling Time to ±1dB	50 ns Typ
Recovery Time	200 ns Max (150 ns Typ)
Droop	1dB Max
SPST Isolation	70 dB Typ
SPST Switch Speed	20 ns Typ

SDLVA, SDLVA-418-65-16MV-12DBM



- Operates between the 4.0 to 18.0 GHz frequency range
- Dynamic range of 65 dB, a nominal log slope of 16.7 mV/dB
- Designed using cutting edge GaAs technology which provides stunning performance and reliability
- Compact package 4.24" x 0.994" x 0.38" with SMA connectors

PARAMETERS	SPECIFICATIONS
Frequency Range	4.0 to 18.0 GHz
TSS	-64 dBm Max
Input Power Handling	+20 dBm
Simultaneous Signal Progression	Simultaneous Signal, 5 dB lower at RF Input, 5 dB lower at output with -45 dBm Min Input Signal
Video Log Range	-55 dBm to +10 dBm
Video Log Linearity	+2.2 dB
Video Frequency Flatness	±4 dB Max
Pulse Width Range	25 ns to CW
Video Rise Time	10 ns Max
Video Fall Time	15 ns Max
Recovery Time	30 ns Max
Delay	<2 ns
Video Output Impedance	35 Ω
RF In/Out Impedance	50 Ω
Input VSWR (50 Ω)	2.0:1 Max

SDLVA, SDLVA-6G18G-CD-1



- > Offers 75 dB Dynamic Range over the frequency range of 6 to 18 GHz
- > Ultra-fast rise time of 10 ns maximum and a recovery time of less than 60 ns
- > Temperature compensated such that log linearity over temperature remains $< \pm 2.5$ dB over the full operating temperature range of -40 °C to $+85$ °C
- > Hermetically Sealed in a compact housing measuring only 3.2" x 1.8" x 0.4" with SMA connectors

PARAMETERS	SPECIFICATIONS
Frequency Range	6.0 to 18.0 GHz
Pulse Range	30 ns to CW
Input Power	+17 dBm CW Max
Flatness	± 2.0 dB Max
Log Linearity	± 2.5 dB Max
Log Range	-70 to +5 dBm
Log Slope	25 mV/dB ($\pm 5\%$)
VSWR	2.0:1 Max
Rise Time	10 ns Max
Recovery Time	60 ns Max
Frequency Range	6.0 to 18.0 GHz
Pulse Range	30 ns to CW
Input Power	+17 dBm CW Max
Flatness	± 2.0 dB Max
Log Linearity	± 2.5 dB Max

Performance

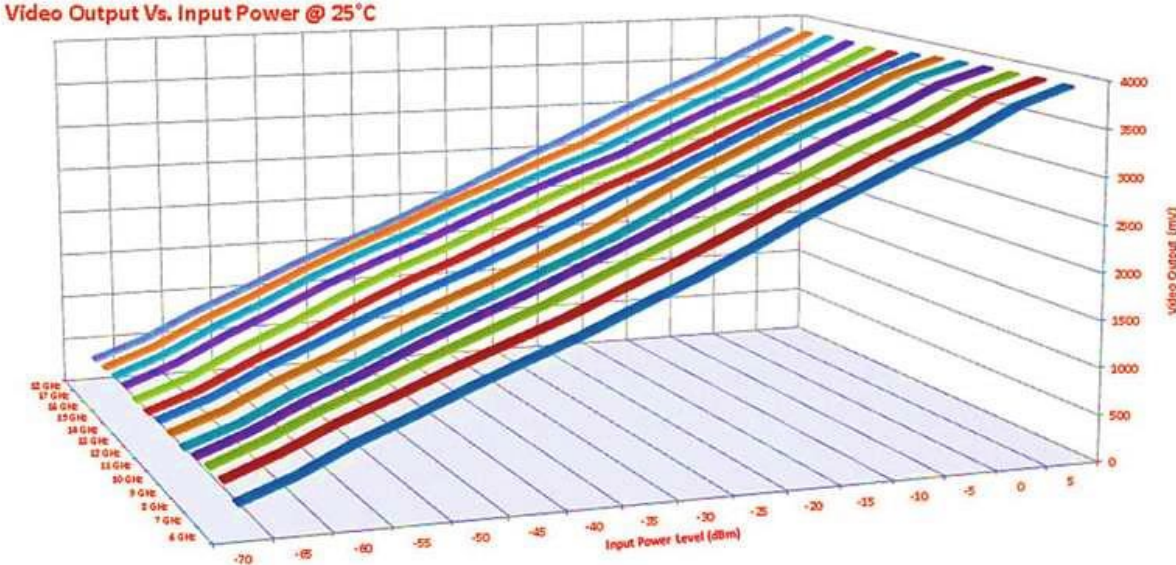
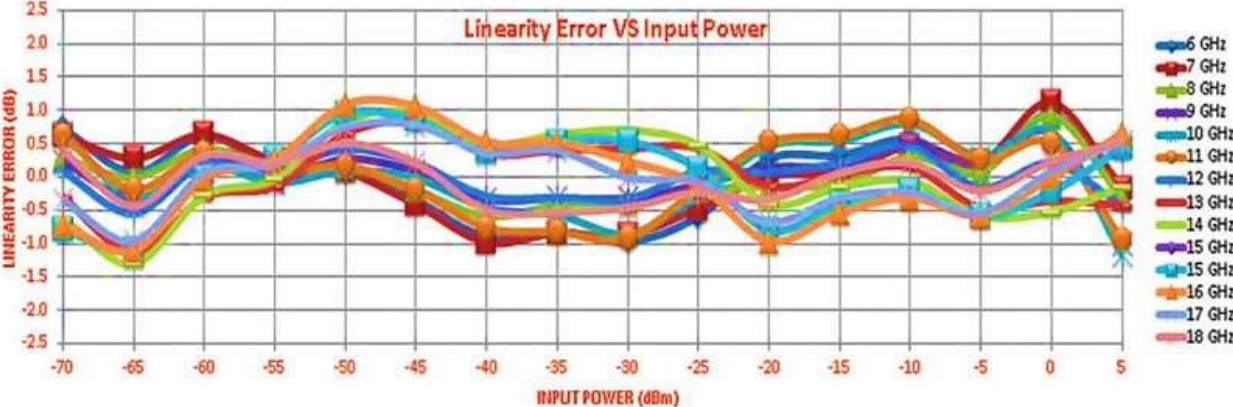

SDLVA, SDLVA-8G18G-40-5-SFF



- > Highly temperature compensated such that the log linearity is better than ± 1 dB over the temperature range of -54 to $+85$ °C
- > Has a logging range of -40 to 0 dBm with an output log video voltage of 10 mV to 2.25 V
- > Features a fast rise / fall time of 25 ns/ 30 ns and a recovery time of less than 40 ns
- > Operating temperature range of -54 to $+85$ °C, but is designed to operate at extended temperature ranges up to $+95$ °C.
- > Supplied in a ruggedized, hermetically sealed housing that measured only 1.2 " x 0.85 " x 0.4 "

PARAMETERS	SPECIFICATIONS
Frequency Range	8.0 to 18.0 GHz
Frequency Flatness	± 2.0 dB
Log Linearity over Temperature	± 1.0 dB Pin= -30 dBm @ -54 to $+85$ °C
Logging Range	-40 to $+0$ dBm
Input VSWR	2.5:1 Max
Max RF INPUT POWER	$+10$ dBm CW
Log Video Output Voltage	10 mV to 2.25 V
Log Video Output Slope	50 mV/dB
Log Video Output Rise Time	25 ns Max @ -20 dBm
Log Video Output Fall Time	30 ns Max @ -20 dBm
Log Video Recovery time	40 ns Max @ -20 dBm
Frequency Range	8.0 to 18.0 GHz
Frequency Flatness	± 2.0 dB
Log Linearity over Temperature	± 1.0 dB Pin= -30 dBm @ -54 °C to $+85$ °C
Logging Range	-40 to $+0$ dBm

Performance

LOG TRANSFER AND RISE / FALL TIME @ +25 °C & 0 dBm

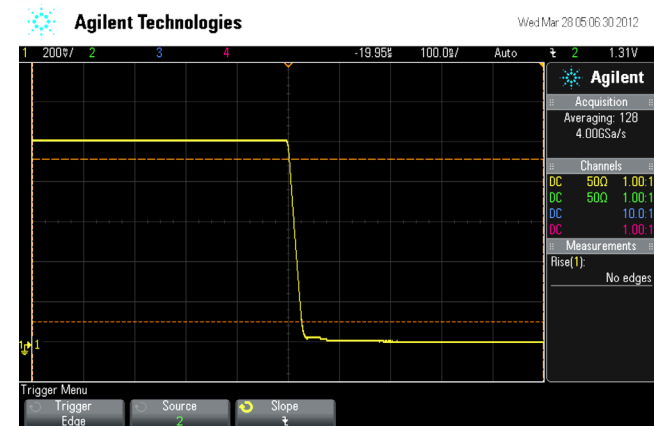
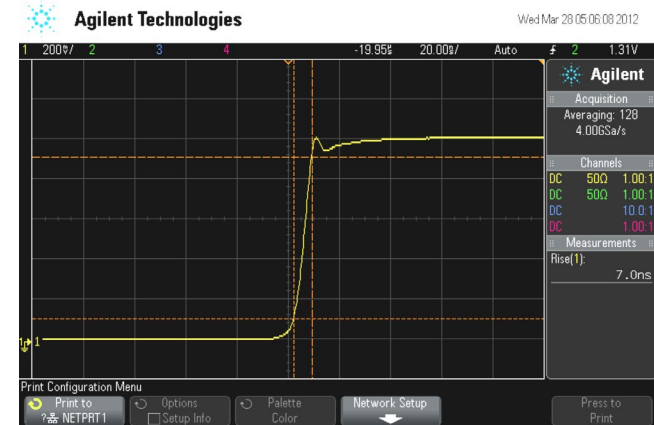
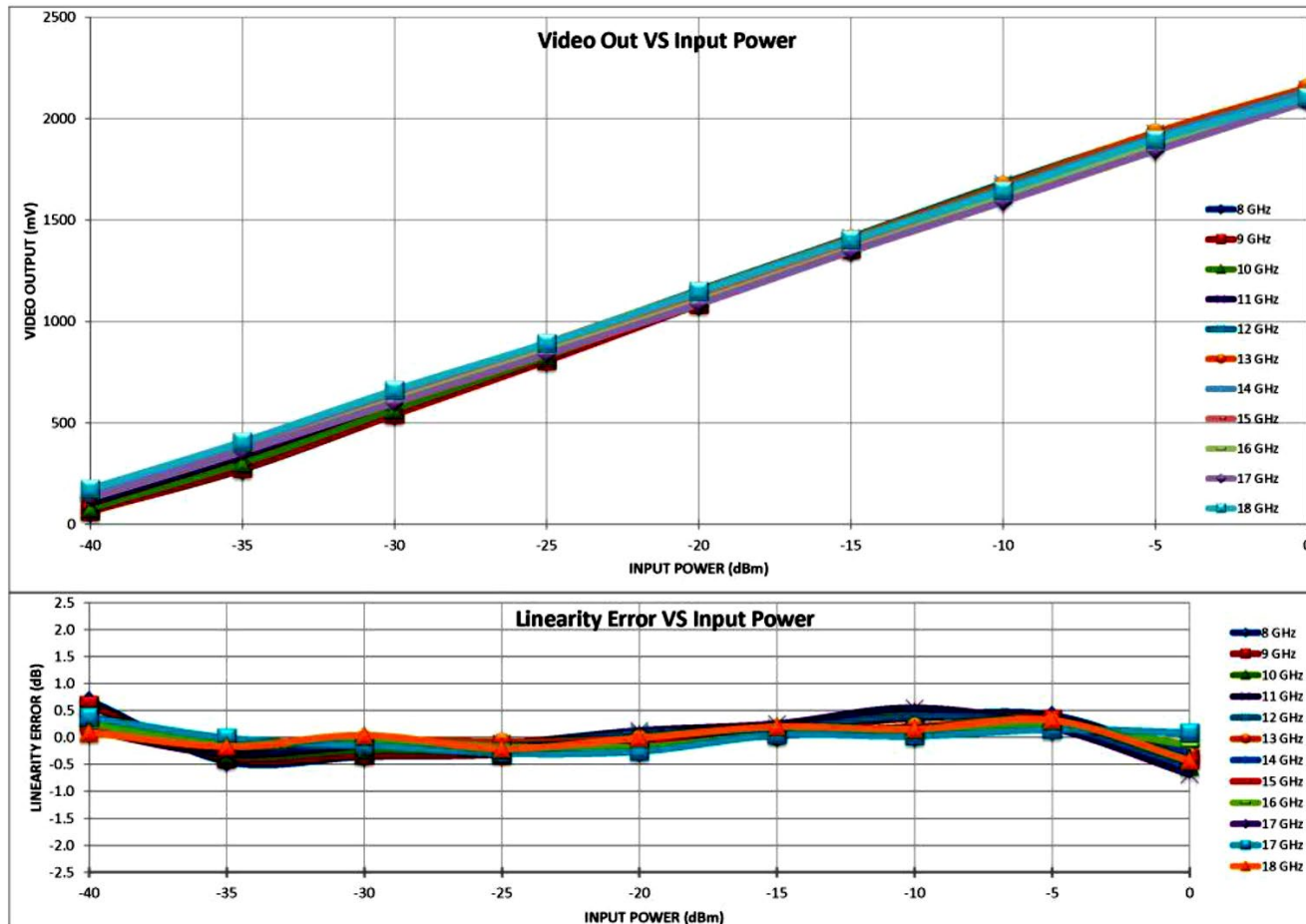

SDLVA, SDLVA-18G40G-65-CD-292FF

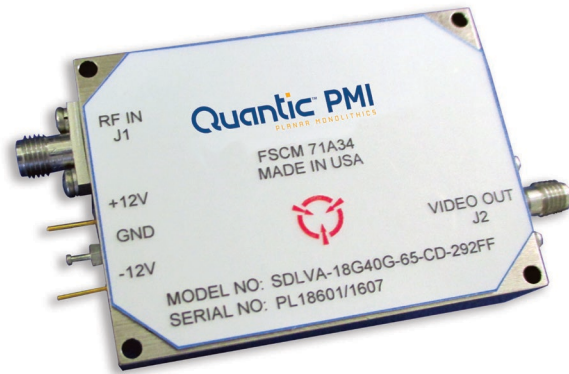

VSWR 2.34:1 @ 25 °C & -20 dBm

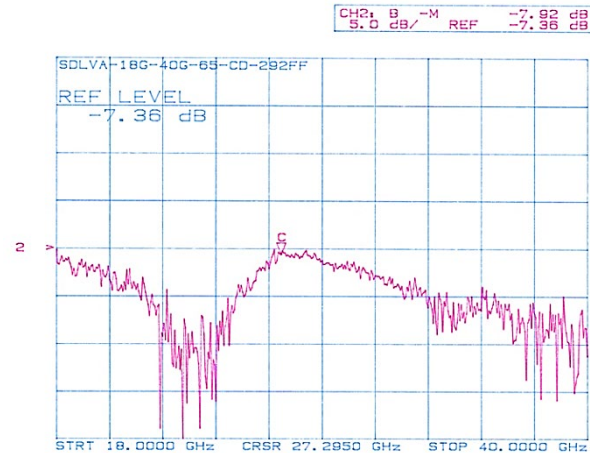

- Operates between the 18.0 to 40.0 GHz frequency range
- Dynamic range of 65 dB, log slope of 25 mV/dB and a nominal video bandwidth of 32 MHz
- Designed using cutting-edge GaAs technology which provides stunning performance and reliability in a compact package making it an optimum solution for high-speed channelized receiver applications

PARAMETERS	SPECIFICATIONS
Frequency Range	18.0 to 40.0 GHz
TSS	-65 dBm @ 25 °C
Input Power Handling	10 dBm Max
Video Log Range	-63 to +2 dBm
Video Log Linearity	+/- 2.0 dB @ 25 °C +/-3.0 over temp
Video Log Slope	25 mV/ dB Nom
Video Log Intercepts	1940 mV Max 1476 mV Max 280 mV Max 65 mV Min
Video Frequency Flatness	+/-2.5 dB Max @ 25 °C
Pulse Width Range	30 ns to CW
Video Rise Time	11 ns (8 ns Typ)
Recovery Time	60 ns (40 ns Typ)
Delay Time	15 ns (5 ns Typ) 7 ns over temp Typ
Video Output Impedance	50 ohms
Input VSWR (50 ohms)	2.5:1

Performance

LINEARITY ERROR vs INPUT POWER

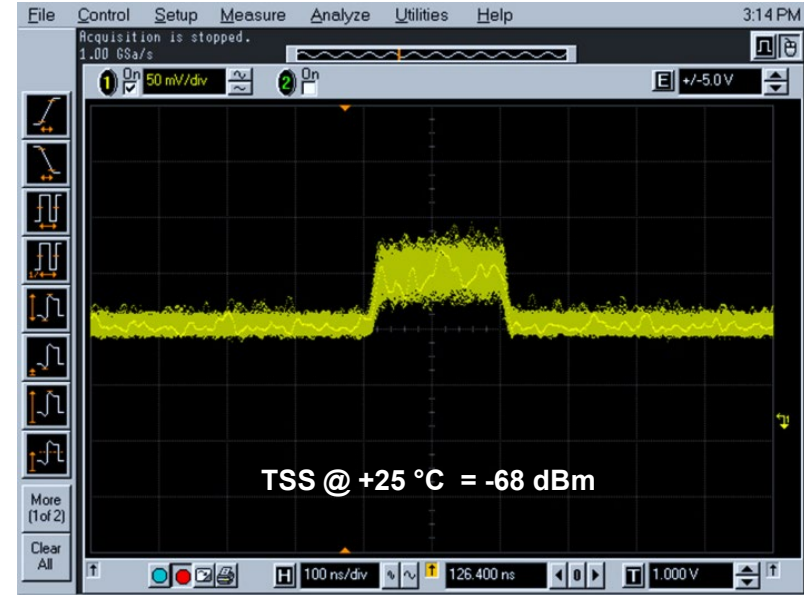
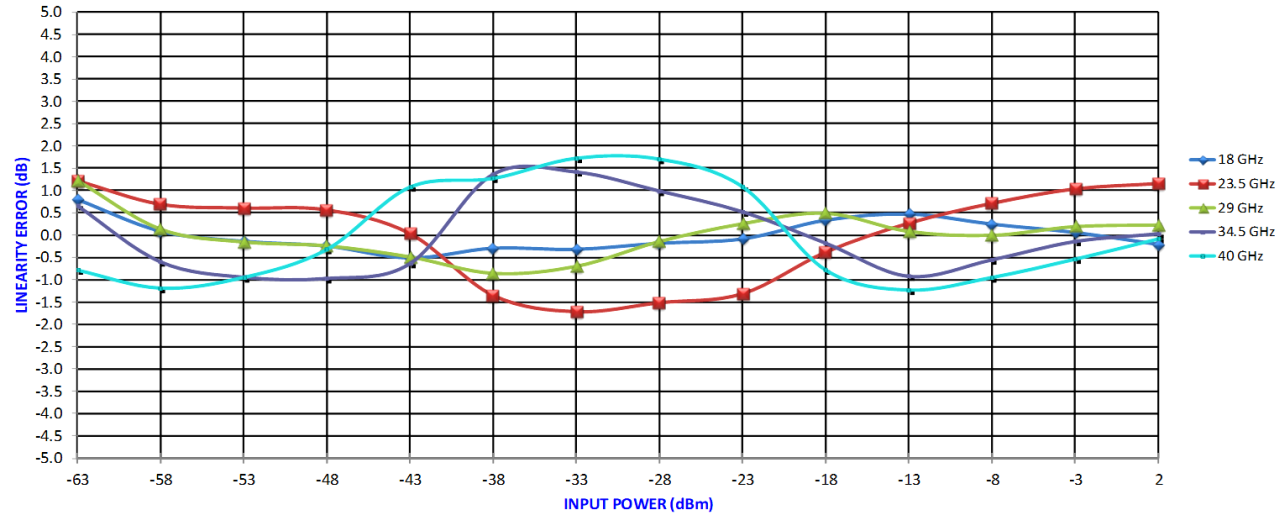

VIDEO OUT vs INPUT POWER

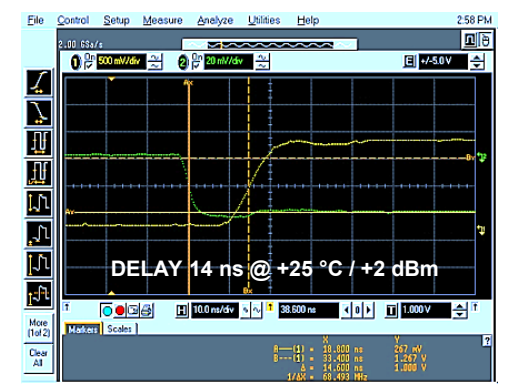
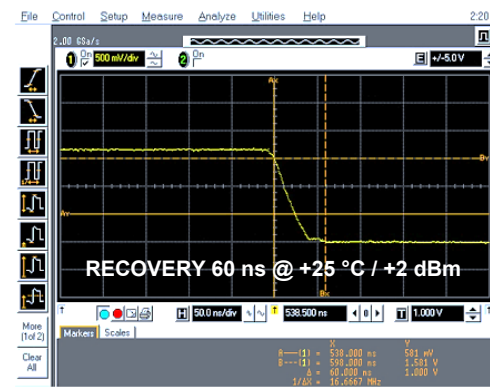
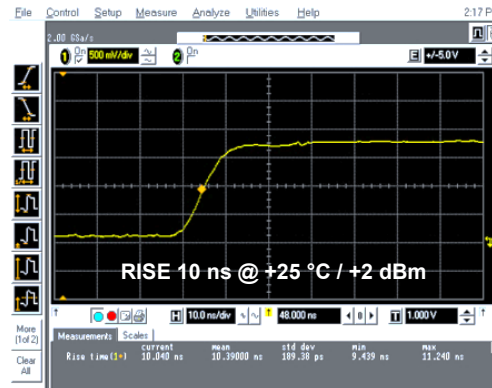
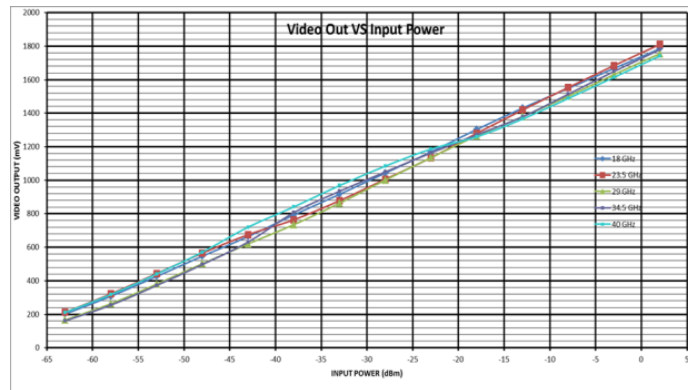

SDLVA, SDLVA-18G40G-65-CD-292FF-A15



- > Operates between the 18.0 to 40.0 GHz frequency range
- > Dynamic range of 65 dB, a log slope of 25 mV/dB, and a Nominal video bandwidth of 32 MHz
- > Designed using cutting edge GaAs technology which provides excellent performance and reliability in a compact package making it an optimum solution for high-speed channelized receiver applications

PARAMETERS	SPECIFICATIONS
Frequency Range	18.0 to 40.0 GHz
TSS	-65 dBm @ 25 °C
Input Power Handling	10 dBm Max
Video Log Range	-63 dBm to +2 dBm
Video Log Linearity	±2.0 dB to +2 dBm ±3.0 over temp
Video Log Slope	25 mV/dB Nom
Video Log Intercepts	1940 mV Max
Video Output at 2 dBm	1476 mV Max
Video Output at -63 dBm	280 mV Max 65 mV Min
Video Freq Flatness	±2.5 dB Max @ 25 °
Pulse Width Range	30 ns to CW
Video Rise Time	11 ns (8 ns Typ)
Recovery Time	60 ns (40 ns Typ)
Delay Time	15 ns (5 ns Typ)
	7 ns over temp Typ
Video Output Impedance	50 ohm
Input VSWR (50 OHM)	2.5:1 - Measured 2.34:1

SDLVA, SDLVA-18G40G-65-CD-292FF-A15

Performance

MODEL: SDLVA-18G40G-65-CD-292FF

DATE: 7-14-15
TESTED BY: J. Merriner
Test Temp: 25C

VOS= 86MV
GRAPH #1



PLANAR MONOLITHICS INDUSTRIES
4921 Robert J. Mathews Parkway Suit 1
El Dorado Hills, CA 95762
TEL: 916-542-1401 FAX: 916-265-2597
EMAIL: SALES@PMI-RF.COM

Frequency		-63	-58	-53	-48	-43	-38	-33	-28	-23	-18	-13	-8	-3	2	RF Input Power (dBm)	
18 GHz	INTERCEPT (mV)	1740															
	SLOPE (mV/dB)	24.7															
		202	308	426	547	664	793	916	1043	1169	1303	1430	1548	1667	1784	Measured Value (mV)	Error(dB)
		20	2	-3	-6	-13	-7	-8	-5	-2	8	12	6	1	-5	Error (mV)	MAX MIN
		0.80	0.09	-0.14	-0.25	-0.51	-0.30	-0.32	-0.18	-0.09	0.33	0.47	0.24	0.06	-0.21	LINEARITY ERROR (dB)	0.80 -0.51
23.5 GHz	INTERCEPT (mV)	1732															
	SLOPE (mV/dB)	24.6															
		212	322	443	565	675	764	878	1006	1134	1280	1419	1553	1684	1810	Measured Value (mV)	Error(dB)
		30	17	15	14	1	-33	-42	-37	-32	-9	7	17	25	28	Error (mV)	MAX MIN
		1.22	0.69	0.61	0.56	0.03	-1.35	-1.72	-1.52	-1.31	-0.38	0.27	0.71	1.03	1.15	LINEARITY ERROR (dB)	1.22 -1.72
29 GHz	INTERCEPT (mV)	1700															
	SLOPE (mV/dB)	24.8															
		166	263	380	502	620	735	863	1001	1135	1265	1379	1501	1630	1755	Measured Value (mV)	Error(dB)
		50	1	-4	-6	-12	21	-17	-4	8	12	5	5	5	5	Error (mV)	MAX MIN
		1.23	0.13	-0.16	-0.24	-0.49	-0.86	-0.70	-0.14	0.25	0.49	0.08	-0.01	0.19	0.22	LINEARITY ERROR (dB)	1.23 -0.86
34.5 GHz	INTERCEPT (mV)	1728															
	SLOPE (mV/dB)	25.1															
		161	255	372	497	631	807	934	1049	1163	1271	1378	1513	1649	1779	Measured Value (mV)	Error(dB)
		17	-15	-24	-24	-16	34	35	25	13	-5	-23	-14	-4	1	Error (mV)	MAX MIN
		0.66	-0.60	-0.95	-0.97	-0.64	1.36	1.41	0.99	0.52	-0.18	-0.93	-0.55	-0.14	0.03	LINEARITY ERROR (dB)	1.41 -0.97
40 GHz	INTERCEPT (mV)	1696															
	SLOPE (mV/dB)	23.3															
		211	318	440	571	720	841	968	1084	1186	1269	1365	1488	1614	1741	Measured Value (mV)	Error(dB)
		-18	-28	-22	-8	25	30	40	40	25	-18	-29	-22	-13	-2	Error (mV)	MAX MIN
		-0.78	-1.19	-0.95	-0.33	1.07	1.27	1.72	1.70	1.08	-0.78	-1.23	-0.95	-0.54	-0.09	LINEARITY ERROR (dB)	1.72 -1.23
Flatness +/- dB		1.00	1.40	1.40	1.50	2.00	2.20	2.10	1.70	1.10	0.90	1.30	1.30	1.40	1.40		
Max Video Output Volts		0.21	0.32	0.44	0.57	0.72	0.84	0.97	1.08	1.19	1.30	1.43	1.55	1.68	1.81		
Min Video Output Volts		0.16	0.26	0.37	0.50	0.62	0.74	0.86	1.00	1.13	1.26	1.37	1.49	1.61	1.74		
Log Slope Variation: ± mV/dB		0.92															
Video Output @ -63dBm	SPEC																
Min(V)=	161.0																
Max(V)=	212.0																
Video Output @ +2dBm	SPEC																
Min(V)=	1741.0																
Max(V)=	1810.0																

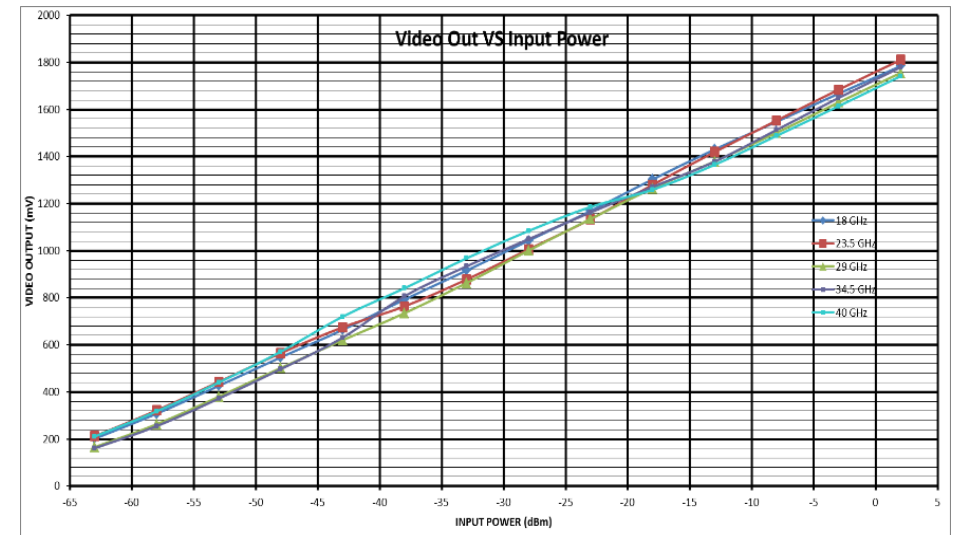
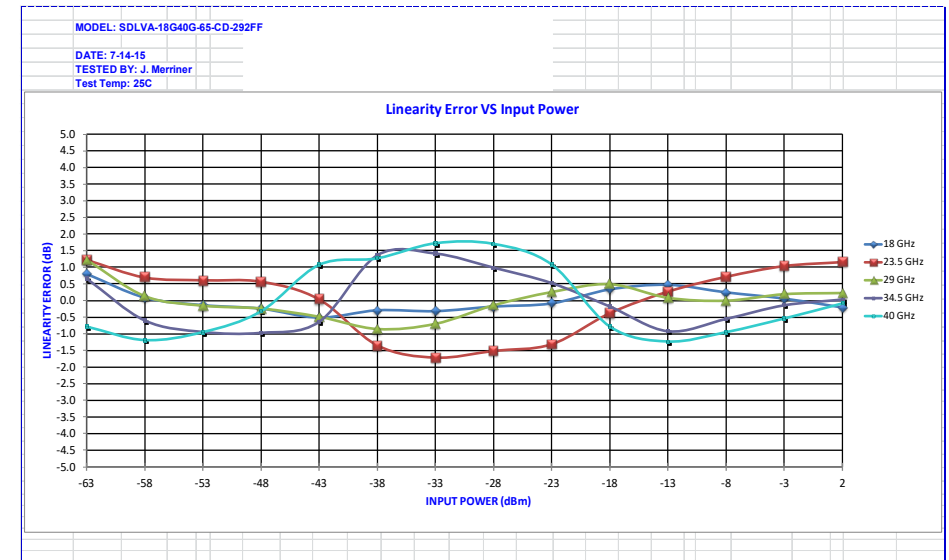

Surface Mount Designs

Standard Designs...

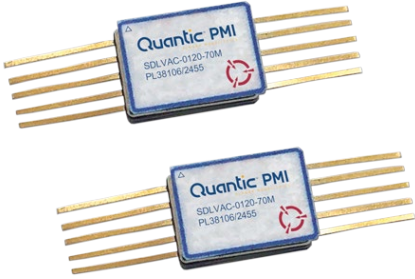

**0.1 to 2 GHz
Surface SDLVA**

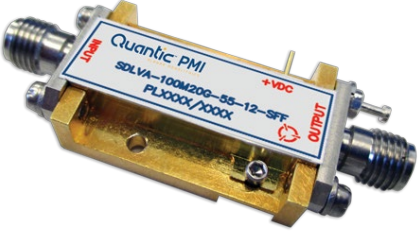

**0.1 to 20 GHz
Miniature SDLVA
(Dual Use)**



**0.3 to 0.8 GHz
Surface SDLVA**

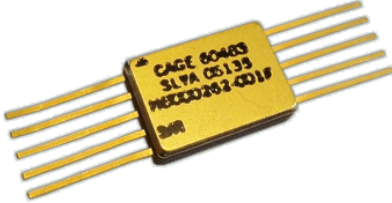

**0.6 to 1.35 GHz
Surface SDLVA**

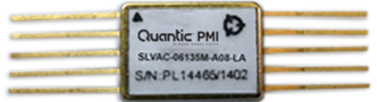

**0.6 to 1.35 GHz
Surface SDLVA**



**1 to 20 GHz
Miniature SDLVA
(Dual Use)v**

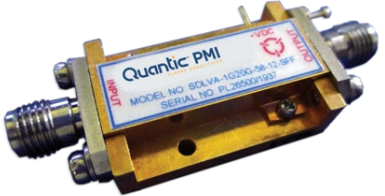

**1 to 20 GHz
Miniature SDLVA
(Dual Use)v**

Surface Mount, SDLVAC-0120-70M

Stunning performance and reliability in a compact package!

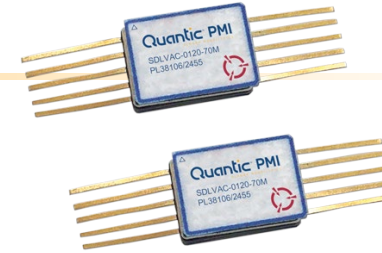

- > Operates over the 0.1 to 2.0 GHz frequency range and has a dynamic range of 65 to 70 dB, a TSS of -67 dBm and a nominal video bandwidth of 20 MHz
- > Designed using cutting edge GaAs technology, which provides stunning performance and reliability in a compact package making it an optimum solution for highspeed channelized receiver applications
- > Offers typical fast rise time of <20 ns, rapid fall time of <25 ns, as well as superior delay time of 8 ns
- > The log slope is 25 mV/dB and the accuracy is less than ± 1.0 dB over the -60 to 0 dBm power input range
- > Dynamic range can be extended to -65 ± 5 dB with log error of ± 1.5 dB. Options are available with adjustable logging slope and DC offsets.
- > Commercially screened and characterized from -55 to +85 °C
- > Sizes available are 0.395" x 0.280" x 0.090" or customized configuration desired

PARAMETERS	SPECIFICATIONS
Frequency Range:	0.1 to 2.0 GHz
Logging Range:	-65 to +5 dBm
Video Load:	100 Ohms
Limited IF Output:	-16 dBm Typ
Dynamic Range:	>65 dB
Log Linearity:	± 1.2 dB Max (-60 to 0 dBm), ± 0.8 dB Typ ± 1.5 dB Max (-65 to +5 dBm), ± 1.2 dB Typ
Maximum RF Input Power:	+10 dBm
Tangential Sensitivity:	-65 dBm Min, -70 dBm Typ
Minimum Logging Range:	-60 dBm, -65 dBm Typ
Maximum Logging Range:	+5 dBm, +8 dBm Typ

Note: Connectorized version is available as Model No. [SDLVA-0120-70](#)

Miniature SDLVA, SDLVA-100M20G-55-12-SFF

Dual use component, connectorized or surface mount



- > Operates from 100 MHz to 20 GHz frequency range, 55 dB dynamic range, and ultra-high speed
- > Unit size and stunning performance makes it an attractive solution for high speed, wide band, and high reliability channelized receiver applications
- > Supplied in Quantic PMI standard PE2 housing (1.08" x 0.71" x 0.29") that can be used as a SMA connectorized or surface mount component.

PARAMETERS	SPECIFICATIONS
Frequency Range:	0.1 to 20.0 GHz
Logging Range:	-50 to +5 dBm
Video Load:	1 K Ohm Min
Log Linearity:	±1.0 dB (Pin = -45 to 0 dBm) @ +25 °C Typ
Input VSWR:	3.0:1 Typ
Log Video Output Slope:	15 mV/dB Typ
Log Video Output Voltage:	0.9 to 1.5 V Typ
Tangential Sensitivity:	-55 dBm Typ
Frequency Flatness:	±2.0 dB Typ
Log Linearity Over Temp:	±1.5 dB (Pin = -45 to 0 dBm @ -55 to +85 °C) Typ
Log Video Output Rise Time:	5 ns (Pin = -20 dBm @ 10% to 90%)
Log Video Output Fall Time:	20 ns (Pin = -20 dBm @ 90% to 10%)
Log Video Recovery Time:	28 ns (Pin = -20 to 0 dBm)
Log Video Propagation Delay:	10 ns Typ
Video Output Load:	1K Min
ESD Sensitivity:	HBM Class 0

Surface Mount, SDLVAC-0120-70M-YK

Designed for high-speed channelized receiver applications.



- > Operates over a frequency range of 300 to 800 MHz
- > Dynamic range of 65 to 70 dB a TSS of -65 dBm and a nominal video bandwidth of 10 MHz
- > Offers typical rise time of 25 ns maximum, fall time of 80 ns maximum and delay time of 40 ns maximum. The log slope is 28 mV/dBm with adjustable resistor
- > Compact Size 0.395" x 0.280" x 0.090"

PARAMETERS	SPECIFICATIONS
Frequency Range:	0.3 to 0.8 GHz
Logging Range:	-65 to +5 dBm
Video Load:	50 Ohms
Log Slope:	23 mV/dB
TSS (Min):	-65 dBm
Limited IF Output:	-16 dBm
Dynamic Range:	65 dB
Tangential Sensitivity:	-65 dBm Max
Log Linearity:	+/-1.2 dB Max (-65 dBm to 0 dBm at 25 °C), +/-1.5 dB Max (-65 dBm to +5 dBm at -54 to +85 °C), +/-1.7 dB Max (-65 dBm to +5 dBm at -54 to +95 °C)
Maximum RF Input Power:	+10 dBm
Limited IF Output Flatness:	+/-3 dBm
IF Small Signal Gain:	45 dB Min
Input/output Impedance:	50 Ohms
Input VSWR:	Input: 2.0:1, Output: 2.0:1
Propagation Delay:	40 ns

Surface Mount, SLVAC-06135M-MA08

Designed for high-speed channelized receiver applications.

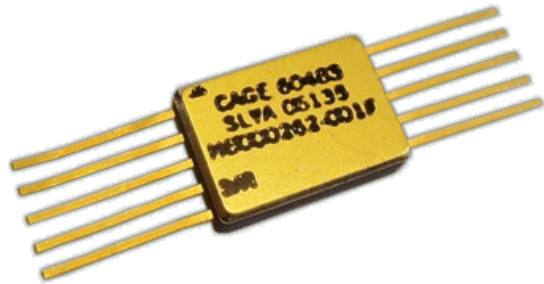

- > Operates over the 0.6 to 1.35 GHz range with a dynamic range of 65 to 70 dB a TSS of -67 dBm and a nominal video bandwidth of 20 MHz
- > Designed using innovative GaAs technology which provides stunning performance and reliability in a compact package
- > This unit offers typical fast rise time <20 ns rapid fall time <25 ns as well as superior delay time of 8 ns. The log slope is 25 mV/dB and the accuracy is less than +/- 1.0 dB over the -60 to 0 dBm power input range
- > Sizes available are 0.75 x 0.75 x 0.135 or any other customized configuration desired. Connectorized versions are available

PARAMETERS	SPECIFICATIONS
Frequency Range:	0.6 to 1.35 GHz
Logging Range:	-65 to +5 dBm
Video Load:	100 Ohms
Log Slope:	25 mV/dB
TSS, Min:	-70 dBm
Limited IF Output:	-14 dBm
Dynamic Range:	65 dB
Log Slope Variation with Frequency:	+/-0.5 mV/dB Typ (over 80 MHz RF BW)
Log Slope Variation with Temperature:	+/-1 mV Typ
Log Linearity:	+/-1.2 dB Max (-60 dBm to 0 dBm), +/-0.8 dB Typ Measured +/-0.6 dB
Maximum RF Input Power:	+10 dBm
Output Voltage:	2.7 V
Log Video Output Settling Time:	40 ns
Propagation Delay:	10 ns Max, 7 ns Typ
Tangential Sensitivity:	-65 dBm Typ

Miniature SDLVA, SLVAC-06135M-A08-LA

Designed for high speed, channelized receiver applications



- > Operates over the 0.6 to 1.35 GHz frequency range
- > Dynamic range of 65 to 70 dB and a TSS of -65 dBm (-70 dBm typical)
- > Designed using cutting edge GaAs technology which provides stunning performance and reliability in a compact package, making it an optimum solution for high speed, channelized receiver applications
- > These units offer fast rise time of ≤ 20 ns, Rapid Fall Time of ≤ 25 ns as well as superior delay time of 8 ns

PARAMETERS	SPECIFICATIONS
Frequency Range:	0.6 to 1.35 GHz
Logging Range:	-65 to +5 dBm
Video Load:	100 Ohms
Log Slope:	30 mV/dB
TSS, Min:	-65 dBm
Limited IF Output:	-18 dBm
Dynamic Range:	65 dB
Tangential Sensitivity:	-65 dBm Min (-70 dBm Typ)
Log Slope Variation with Frequency:	± 0.5 mV/dB Typ (over 80 MHz RF Bandwidth)
Log Slope Variation with Temperature:	± 1 mV Typ
Log Linearity:	± 1.2 dB Max (-60 dBm to 0 dBm), ± 0.8 dB Typ , ± 1.5 dB Max (-65 dBm to +5 dBm), ± 1.2 dB Typ
Maximum RF Input Power:	+10 dBm
Output Voltage:	2.7 V
Log Video Output Settling Time:	40 ns
Propagation Delay:	10 ns Max, 7 ns Typ

Miniature SDLVA, SDLVA-1G20G-55-12-SFF

Dual use component, connectorized or surface mount



- > Operates from 1 to 20 GHz frequency range, 55 dB dynamic range, and ultra-high speed
- > Unit size and stunning performance makes it an attractive solution for high speed, wide band, and high reliability channelized receiver applications
- > Supplied in Quantic PMI standard PE2 housing (1.08" x 0.71" x 0.29") that can be used as a SMA connectorized or surface mount component.

PARAMETERS	SPECIFICATIONS
Frequency Range:	1.0 to 20.0 GHz
Logging Range:	-55 to +5 dBm
Video Load:	50 Ohm Load
Log Linearity:	±1.5 dB (Pin = -50 to 0 dBm) @ +25 °C Typ
Input VSWR:	2.8:1 Typ
Log Video Output Slope:	50 mV/dB Typ
Log Video Output Voltage:	0.1 to 2.5 V Typ
Tangential Sensitivity:	-58 dBm TSS Typ
Frequency Flatness:	±2.0 dB Typ
Log Linearity Over Temp:	±2.0 dB (Pin = -50 to 0 dBm) @ -55 to +85 °C Typ
Log Video Output Rise Time:	5 ns (Pin = -20 dBm @ 10% to 90%)
Log Video Output Fall Time:	20 ns (Pin = -20 dBm @ 90% to 10%)
Log Video Recovery Time:	28 ns (Pin = -50 to 0 dBm)
ESD Sensitivity:	HBM Class 0

Miniature SDLVA, SDLVA-1G20G-58-12-SFF

Dual use component, connectorized or surface mount



- > Excellent performance packed into an ultra-small package
- > 1 to 20 GHz ultra-wide frequency range and 59 dB dynamic range makes this part suitable for a multitude of applications
- > Features low power consumption of 1.2 W and a single operating voltage of +12 V
- > Supplied in Quantic PMI standard PE2 housing (1.08" x 0.71" x 0.29") that can be used as a SMA connectorized or surface mount component

PARAMETERS	SPECIFICATIONS
Frequency Range:	1.0 to 20.0 GHz
Logging Range:	-54 to +5 dBm
Video Load:	1 K Min
Log Linearity:	±1.0 dB (Pin = -50 to 0 dBm) Typ
Log Video Output Slope:	14 mV/dB Typ
Size:	1.08" x 0.71" x 0.29"
Maximum Power:	+12 dBm CW (Max)
Log Video Output Voltage:	0.9 to 1.5 V Typ
Tangential Sensitivity:	-60 dBm TSS Typ
Log Linearity Over Temp:	±1.0 dB (Pin = -30 dBm @ -55 to +85°C) Typ
Log Video Output Rise Time:	5 ns (Pin = -20 dBm @ 10% to 90%)
Log Video Output Fall Time:	20 ns (Pin = -20 dBm @ 90% to 10%)
Log Video Recovery Time:	28 ns (Pin = -50 to 0 dBm)
Log Video Propagation Delay:	15 ns
Video Output Load:	1 K Min
ESD Sensitivity:	HBM Class 0

Quantic PMI is a Leader in EOL and Obsolete Aftermarket Manufacturing

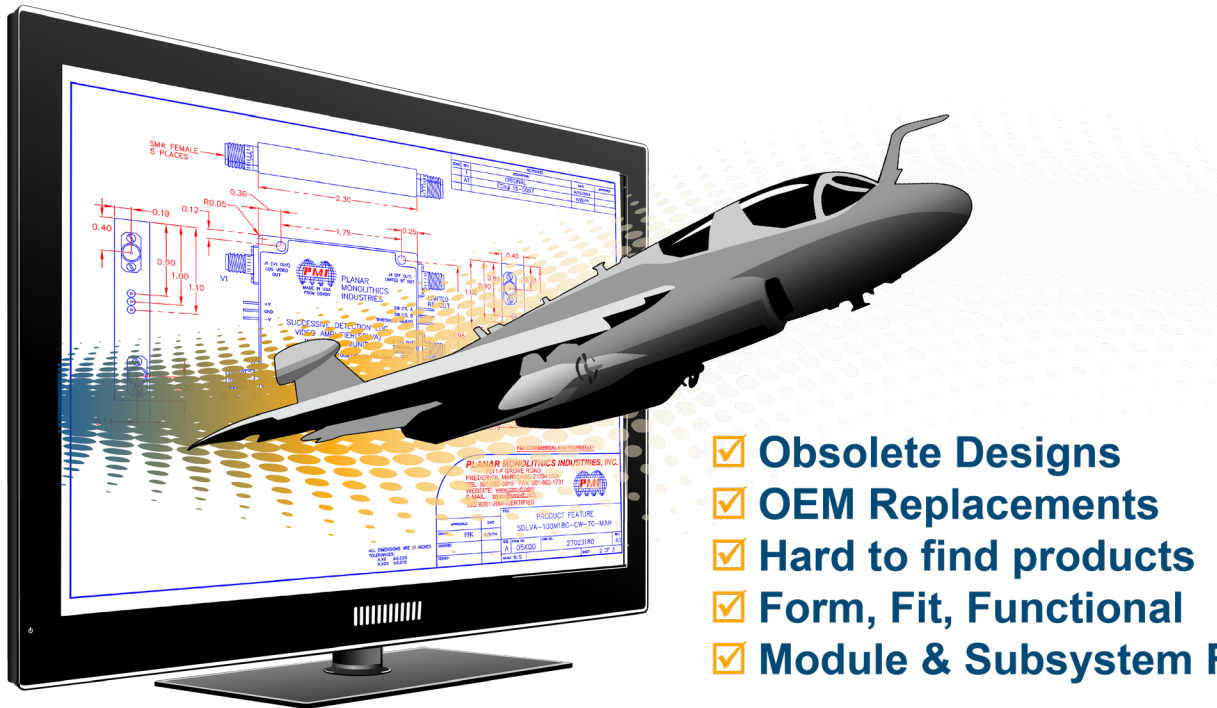

- ✓ Obsolete Designs
- ✓ OEM Replacements
- ✓ Hard to find products
- ✓ Form, Fit, Functional
- ✓ Module & Subsystem Retrofits

- > Using Source Control Drawings (SCD), Quantic PMI offers a complete solution to meet or exceed the electrical, mechanical and environmental specifications.
- > Specializing in aftermarket technology manufacturing and support for discontinued RF components, electronic circuits, digital circuits and Integrated circuits.
- > Quantic PMI has the technical expertise to manufacture, supply and support these requirements.
- > Quantic PMI is dedicated to assuring our customer base that older discontinued products will continue to be available.

Thank You!

